



LASER CATALOG

A PROGRESSIVE COMPANY FOR AN EVOLVING MARKET



Over a period of 28 years, the THERMACUT® Group has undergone a multitude of changes. THERMACUT® (originally Tatras Imports Inc.) was incorporated in Claremont, New Hampshire in 1990 and sold products under the brand ZAP Plasmatherm, a reseller of plasma consumables from local vendors directly to end-users. The company began operating with three employees, conducting business through telephone sales. In 1992, the company opened a small manufacturing facility in the Czech Republic, followed by a sales office there in 1996. The Czech facility was created to produce and sell plasma consumables and torches directly into the Eastern European market and through distributors in Western Europe under the brand name THERMACUT®, utilizing both inside and outside sales representatives. And in 1993 the THERMACUT® brand was introduced into North America and sold through distributors.

In January of 1999, STK Gesellschaft für Schweißtechnik GmbH (a holding company 100% owned by the IBG Group of Cologne, Germany) purchased 80% of the shares of THERMACUT® and in 2002 completed the acquisition to become the 100% shareholder of the THERMACUT® Group.

Since those early and humble beginnings, THERMACUT® has evolved into a major force in providing plasma torches and consumables through multiple sales channels supported by ten sales subsidiaries. THERMACUT® also has a close partnership with Abicor-Binzel (an IBG owned company) with locations in India, the Middle East, Turkey, Belarus, Kazakhstan, Denmark, Norway, Sweden, Finland, United Kingdom, South Korea, Australia, Mexico, and Brazil. Based on customer demand, THERMACUT® has also introduced TIG/WIG, MIG/MAG and Oxy-fuel products and produces those products at its modern ISO 9001 production facility located in Uherske Hradiste in the Czech Republic.

The THERMACUT® Group has focused its efforts on providing high quality, direct replacement consumable and torch product lines that will meet or exceed the expectations of our valued customers who are cutting and welding metals thermally throughout the world. As our customer base grew, their expectations and demands also increased. In 2005, THERMACUT® expanded its product portfolio with the addition of advanced consumables, which have included products such as the Silver Plus™, Silver Pro™ and Silver-EX® electrodes, plus the patented Tungsten-EX™ nozzles.

By 2013, the THERMACUT® Group continued to expand and evolve in the thermal cutting and welding marketplace. In December of 2012, the THERMACUT® Group concluded the purchase of the HOLMA® AG, a producer of premium quality laser consumables, which satisfies ongoing requests from customers for a high quality laser consumable brand and a further expansion of THERMACUT's plasma cutting and oxy-fuel consumable product portfolio.

In September 2013 at the SCHWEISSEN & SCHNEIDEN Exposition, the THERMACUT® Group evolved once again with the introduction of a line of plasma cutting systems for both manual and mechanized plasma processes up to 65 mm thickness. The initial introduction featured a 105 amp system. THERMACUT® also had 65 and 85 amp systems on display. With this change, THERMACUT® has made clear to its customers around the world its intention to move into the position of a producer of a full range of original plasma products.

From 2016 to 2018, plasma power sources from 30 A to 125 A were gradually introduced. The HD series, along with its original torches and the patented Torch Connection System (TCS) connector, was launched in 2017 at SCHWEISSEN & SCHNEIDEN in Dusseldorf.

As with plasma cutting, THERMACUT® is the leader in the field of laser cutting technology. In 2017 at SCHWEISSEN & SCHNEIDEN, we presented the original EX-TRABEAM® laser head, which was launched in the second half of 2018.

Throughout the life of the THERMACUT® Group, we have believed that "The customer is always right." This is what motivates us to improve in all areas, starting with the development of all products and ending their sales.

"THE CUTTING COMPANY" is not just a slogan for us. It is an established practice. Join THERMACUT® in the world of cutting to discover new and alternative applications, and take full advantage of new possibilities offered by the digital cutting world.



ADDRESSES AND CONTACTS

CZECH REPUBLIC

THERMACUT, k.s.
Headquarters and Production
Sokolovská 574, Mařatice
686 01 Uherské Hradiště
Tel.: +420 572 420 411
Fax: +420 572 420 420
E-mail: info@thermacut.cz
reditelstvi@thermacut.cz
www.thermacut.cz

CZECH REPUBLIC

THERMACUT, k.s.
Central Sales Department
Dukelská 76A
742 42 Šenov u Nového Jičína
Tel.: +420 556 423 418, 440
E-mail: sales@thermacut.cz
obchod@thermacut.cz
www.thermacut.cz

SUBSIDIARIES

GERMANY

THERMACUT GMBH
Am Rübgarten 2
D-57299 Burbach
Tel.: +49 2736 294911-0
Fax: +49 2736 294911-77
E-mail: info@thermacut.de
www.thermacut.de

USA

THERMACUT, Inc
153 Charlestown Road
Claremont, NH 03743
Tel.: +1 (800) 932-8312
+1 (603) 543-0585
Fax: +1 (800) 972-6255
+1 (603) 542-2867
E-mail: sales@thermacut.com
www.thermacut.com

CHINA

TMT (Shanghai) Cutting and Welding
Equipment Co., Ltd.
Room 206 2/F, B Block, Eternal Asia Plaza,
No. 3333 Shenjiang Road, Shanghai
Post: 201206
Tel.: 021-50390667
Fax: 021-50390677
E-mail: thermacut@weldstone.cn

JAPAN

Thermacut Japan Ltd.
3F Shin-Osaka Hankyu Building
1-1-1, Miyahara, Yodogawa-ku, Osaka
532-0003 Japan
Mob.: +81 (0)80 4738 9752
Tel.: +81 (0)6 7662 8857
Fax: +81 (0)6 7668 8301
E-mail: s.miura@thermacut.jp

POLAND

THERMACUT-POLAND Sp. z o.o.
ul. Stawowa 20
43-400 Cieszyn
Tel.: +48 33 852 13 34
+48 33 852 39 71
E-mail: thermacut@thermacut.pl
www.thermacut.pl

ROMANIA

THERMACUT ROMANIA SRL
B-dul 1 Decembrie 1918
nr. 127A
540445 Targu Mures,
Jud. Mures
Tel.: +40 265 263 205
Fax: +40 265 250 317
E-mail: office@thermacut.ro
www.thermacut.ro

SUBSIDIARIES

SLOVAKIA

THERMACUT SLOVAKIA, s.r.o.

Priemyselná 1239

931 01 Šamorín

Tel.: +421 31 591 0121

+421 31 591 0122

E-mail: obchod@thermacut.sk

www.thermacut.sk

UKRAINE

ТОВ «ТЕРМАКАТ УКРАЇНА ГМБХ»

вул. Чорновола, 18,

с. Святопетрівське,

Бучанський район, Київська обл.,

08141, Україна

Тел.: +38 044 403 1699

+38 050 444 2245

+38 050 336 3391

E-mail: info@thermacut.ua

www.thermacut.ua

SALES COOPERATION WITH ABICOR-BINZEL

AUSTRALIA

Binzel PTY Ltd.
42 Hinkler Road
Mordialloc
Victoria 3195
Tel.: +61 (0)3 9587 8522
Fax: +61 (0)3 9580 8796
E-mail: sales@thermacut.com.au

BELARUS

IOOO «ABICOR BINZEL Technics»
ul. Timirjazeva 97-10
BY-220020 Minsk
Tel.: +375 29 5 800 300
E-mail: info@thermacut.by

BRAZIL

BINZEL DO BRASIL INDUSTRIAL Ltda
Estrada União e Indústria, Km 15,5-Lt 17,
Pedro do Rio,
Petrópolis - Rio de Janeiro, CEP 25750-226
Tel.: +55 (24) 2222-9799
+55 (24) 2222-9789
Mob.: +(24) 98134-2676
Fax: +55 (24) 2222-9789
E-mail: thermacut@thermacut.com.br
www.thermacut.com.br

CROATIA

ABICOR BINZEL ADRIA d.o.o.
De Franceschijeva 52
HR-52000 Pula

THERMACUT address:
Petra Preradovića 21
HR-53270 Senj
Tel.: +385 98 424 618
+385 98 365 618
E-mail: thermacut@gs.t-com.hr
www.thermacut.com

DENMARK

Abicor Binzel A/S Denmark
Ringugngsgatan 4
SE-216 16 Limhamn
Tel.: 0045-43621633
Fax: 0045-43622324
E-mail: ac@binzel.se, ket@binzel.se
www.binzel-abicor.com

FINLAND

ABICOR BINZEL Finland Oy
Kartanontie 53
28430 Pori
Tel.: +358 2 634 4600
Fax: +358 2 634 4650
E-mail: info@binzel.fi

FRANCE

THERMACUT FRANCE
6 Rue des Frères Lumiere
67201 Eckbolsheim
Tel.: +33 3 88 76 58 75
E-mail: thermacut@thermacut.fr
www.thermacut.fr

GREAT BRITAIN

Abicor Binzel UK Ltd
Binzel House,
Mill Lane
Winwick Quay
Warrington,
WA2 8UA,Cheshire
Tel.: +44 1925 653944
Fax: +44 1925 654861
E-mail: info@abimail.co.uk
www.thermacut.uk

INDIA

ABICOR BINZEL TECHNOWELD PVT LTD
SNo: 297, Indo German Technology park
Urawade
Mulshi
Pune- 412 115
Phone: 020-66743914, 020-39502691
E-mail: commercial@abicor-india.com

KAZAKHSTAN

THERMACUT
Республика Казахстан.
010000, г. Астана
пр. Республики 68, БЦ «Маржан» офис 116
Моб.: +7 777 826 4242
Тел.: +7 717 262 5730
E-mail: info@thermacut.com.kz
www.thermacut.kz

SALES COOPERATION WITH ABICOR-BINZEL

MEXICO

BINZEL MEXICO S.A. de C.V.
C. Municipio de Tepezalá No. 109
de Arteaga No. 102
Valle de Ags., C.P. 20358
San Fco. de los Romo, Ags.
Tel.: +52 (449) 1581765
Fax: +52 (449) 9731388
E-mail: info@thermacut.com.mx
www.thermacut.com.mx

NORWAY

Binzel Norge AS
Industriveien 6
N-3300 Hokksund
Tel.: 0047-32 25 19 90
E-mail: post@binzel.no

SOUTH KOREA

Abicor Binzel Korea Ltd.
#A-101, 263, Gaejwa-ro
Guemjeong-gu
Busan
Tel.: 0082 (31) 732 6065 / 6066 / 6067
Fax: 0082 (31) 732 6064
E-mail: don.kim@binzel.kr

SWEDEN

Alexander Binzel AB
Ringugnsgatan 4
S-21616 Limhamn
Tel.: 0046- 40 6 991 750
Fax: 0046- 40 6 991 770
E-mail: order@binzel.se

TURKEY

ABICOR BINZEL Kaynak Teknik
Ticaret LTD. STI.
Girne Mah. Irmak Sok. Küçükyali iş Merkezi E
Blok
No:72-6E PK:34852
Maltepe Istanbul Türkiye
Tel.: +90 (216) 367 90 00
Fax: +90 (216) 367 90 14
E-mail: satisdestek@binzel-abicor.com.tr
www.thermacuttr.com

UNITED ARAB EMIRATES

ABICOR BINZEL MIDDLE EAST FZE
P.O Box: 86026, WFZ-04/27, RAKIA Freezone,
Jazeera al Hamra
Ras al Khaimah, United Arab Emirates
Mob.: +971 50 377 1348
Tel.: +971 (7) 2432355
Fax: +971 (7) 2432356
E-mail: info@binzel-abicor.ae

OTHER SALES COOPERATION

ARGENTINA

Maquinas Y Soldaduras Sociedad Anonima
Loreto Virrey 3678
CABA C 1427
Argentina
Tel.: 011 45515999 / 6374
E-mail: administracion@maquisol.com

HUNGARY

COOPTIM HEGESZTÉSTECHNIKA Kft.
Budafoki ÚT 10
2030 Érd
Tel.: +36 (23) 521 430
E-mail: aruhaz@cooptim.hu
www.cooptim.hu

SOUTH AFRICA

TORCH TECH Supplies cc.
Head Office
5 Main reef road Unit 22
Main Reef Park
Dunswart
Boksburg, Gauteng
Tel.: 010 007 0476
E-mail: paul.botha@torchtech.co.za
www.torchtech.co.za

TABLE OF CONTENTS

LASER

SYSTEM	PAGE
THERMACUT® REPLACEMENT PARTS SUITABLE FOR	
AMADA®	8-10
BYSTRONIC®	11-14
CINCINNATI®	15
MAZAK®	16-18
MAZAK® (FOR US MARKET ONLY)	19-23
MITSUBISHI®	24-25
PRECITEC®, BLM®	26-31
PRIMA POWER®	32-33
TRUMPF®	34-44
RAYTOOLSTM	45
BODORTM	45

THERMACUT®, THE CUTTING COMPANY®, FHT-EX®, EX-TRAFIRE®, EX-TRACK®, EX-TRABEAM® AND EX-TRAFLEAME® ARE REGISTERED TRADEMARKS OF THERMACUT, K.S. AND MAY BE REGISTERED IN CZECH REPUBLIC AND/OR OTHER COUNTRIES. ALL OTHER TRADEMARKS ARE PROPERTIES OF THEIR RESPECTIVE OWNERS. THERMACUT® IS NO WAY AFFILIATED WITH AMADA®, BLM® ADIGE™, BODORTM, BYSTRONIC®, CINCINNATI®, MAZAK®, MITSUBISHI®, Precitec®, PRIMA POWER®, RAYTOOLSTM, TRUMPF®.

THERMACUT® REPLACEMENT PARTS SUITABLE FOR AMADA®

Part No.	Ref. No.	Description	Std. Pkg.	Part No.	Ref. No.	Description	Std. Pkg.
HG11.521	AL360	Nozzle Holder	1pc	HG11.522	AL392	Nozzle Holder Insert	1pc

SUITABLE FOR AMADA® LASER AHS™ 100

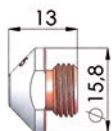

HG10.508

Part No.	Ref. No.	Description	Std. Pkg.	Part No.	Ref. No.	Description	Std. Pkg.
HG10.508	62094006-1.3	Nozzle 1.3mm M10 × 1 HCP	10pcs	HG10.506	62094006-2.0	Nozzle 2.0mm M10 × 1 HCP	10pcs

SUITABLE FOR AMADA® F.O.™

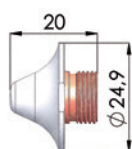

HG10.608–HG10.614, HG10.619

Standard/Double copper nozzles with chromium plating

Part No.	Ref. No.	Description	Std. Pkg.	Part No.	Ref. No.	Description	Std. Pkg.
HG10.609	1572362-0.8	Nozzle 0.8mm HCP	10pcs	HG10.594	1572361-1.2	Double Nozzle 1.2mm HCP	10pcs
HG10.619	1572359	Nozzle 1.0mm HCP	10pcs	HG10.592	1572361-1.4	Double Nozzle 1.4mm HCP	10pcs
HG10.610	1572362-1.2	Nozzle 1.2mm HCP	10pcs	HG10.595	1572361-2.0	Double Nozzle 2.0mm HCP	10pcs
HG10.613	1572362-1.4	Nozzle 1.4mm HCP	10pcs	HG10.618	1572361-2.5	Double Nozzle 2.5mm HCP	10pcs
HG10.608	1572362-1.5	Nozzle 1.5mm HCP	10pcs	HG10.599	1572361-3.0	Double Nozzle 3.0mm HCP	10pcs
HG10.611	1572362-2.0	Nozzle 2.0mm HCP	10pcs	HG10.593	1572361-4.0	Double Nozzle 4.0mm HCP	10pcs
HG10.612	1572362-3.0	Nozzle 3.0mm HCP	10pcs	HG10.759	71515853	PTFE ring	1pc
HG10.614	1572362-4.0	Nozzle 4.0mm HCP	10pcs				

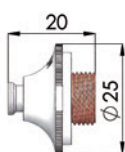

HG10.763, HG10.765, HG10.766

Part No.	Ref. No.	Description	Std. Pkg.	Part No.	Ref. No.	Description	Std. Pkg.
HG10.763	HG10.763	WACS - Double Nozzle 1.7mm with holes Hard chrom (PTFE Ring included)	1pc	HG10.766	71712336	WACS - Double Nozzle 4.0mm with holes Hard chrom (PTFE Ring included)	1pc
HG10.765	71712335	WACS - Double Nozzle 2.5mm with holes Hard chrom (PTFE Ring included)	1pc	HG10.773	71341728	Clean Cut Double Nozzle 4.0mm HCP	1pc
				HG10.776	71341729	Clean Cut Double Nozzle 7.0mm HCP	1pc

PolyTetraFluoroEthylene is a fluorocarbon-based polymer and is commonly abbreviated PTFE. The Teflon® brand of PTFE is manufactured only by DuPont® and is not sold by THERMACUT®. THERMACUT® purchases other brands of PTFE from various high quality manufacturers.

Last update of this page: 22/08/2022. See Revision history for details.

THERMACUT® REPLACEMENT PARTS SUITABLE FOR AMADA® AMADA® LC-3015 X1™

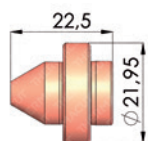

HG12.507

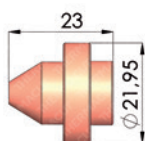

HG12.508

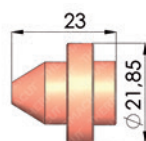

HG12.509

Part No.	Ref. No.	Description	Std. Pkg.	Part No.	Ref. No.	Description	Std. Pkg.
HG11.500	HG11.500	Nozzle 0.8mm Fe CP	10pcs	HG12.531	OD HG12.531	Nozzle 1.7mm	10pcs
HG11.501	71570021	Nozzle 1.0mm Fe CP	10pcs	HG12.508	BQ943D157H02	Nozzle 2.0mm	10pcs
HG11.502	71570020	Nozzle 1.2mm Fe CP	10pcs	HG12.509	BQ943D157H03	Nozzle 2.5mm	10pcs
HG11.503	HG11.503	Nozzle 1.4mm Fe CP	10pcs	HG12.520	BQ943D269H01	Nozzle 1.2mm	10pcs
HG11.504	71570022	Double Nozzle 2.0mm Fe CP	10pcs	HG12.530	BQ933D094H01	Nozzle Nut, Short (length 15mm)	1pc
HG11.505	HG11.505	Double Nozzle 2.5mm Fe CP	10pcs	HG12.501	BQ943D156H01	Double Nozzle Insert 8-holes	10pcs
HG11.506	HG11.506	Double Nozzle 4.0mm Fe CP	10pcs	HG12.504	BQ943D156H03	Double Nozzle Insert 24-holes	10pcs
HG12.507	BQ943D157H01	Nozzle 1.5mm	10pcs				

LENSES SUITABLE FOR AMADA® LC-3015 X1™

PRODUCT BROCHURE WITH DETAILS AT WWW.THERMACUT.COM
 VIDEO AVAILABLE AT YOUTUBE CHANNEL ▶



Part No.	Ref. No.	Description	Std. Pkg.	Part No.	Ref. No.	Description	Std. Pkg.
HG15.028/H	HG15.028/H	7.50" ZnSe Plano-convex lens High pressure lens (19bar), 50.8mm Effective focal length: 190.5mm Edge thickness: 7.87mm AR/AR for 10.6µm (absorption <0.20%)	1pc	HG15.028/HU	HG15.028/HU	7.50" ZnSe Plan.-con. - ULTRA LOW High pressure lens (19bar), 50.8mm Effective focal length: 190.5mm Edge thickness: 7.87mm AR/AR for 10.6µm (absorption <0.13%)	1pc

OD ON DEMAND – WE DO NOT KEEP THESE PARTS IN STOCK, COST IS SET ACCORDING TO THE ORDERED QUANTITY, DELIVERY TIME MAY DIFFER FROM STANDARD PRODUCTS.

Last update of this page: 05/01/2024. See Revision history for details.

THERMACUT® REPLACEMENT PARTS SUITABLE FOR AMADA®

LENSES SUITABLE FOR AMADA®



Part No.	Ref. No.	Description	Std. Pkg.	Part No.	Ref. No.	Description	Std. Pkg.
HG10.167/H	M78025	5.00" ZnSe Meniscus lens High pressure lens (29bar), 38.1mm Effective focal length: 127.0mm Edge thickness: 7.4mm AR/AR for 10.6µm (absorption <0.20%)	1pc	HG10.167/HU	M78025UL	5.00" ZnSe Men. lens - ULTRA LOW High pressure lens (29bar), 38.1mm Effective focal length: 127.0mm Edge thickness: 7.4mm AR/AR for 10.6µm (absorption <0.13%)	1pc
HG10.168/H	M78026	7.50" ZnSe Meniscus lens High pressure lens (29bar), 38.1mm Effective focal length: 190.5mm Edge thickness: 7.4mm AR/AR for 10.6µm (absorption <0.20%)	1pc	HG10.168/HU	M78026UL	7.50" ZnSe Men. lens - ULTRA LOW High pressure lens (29bar), 38.1mm Effective focal length: 190.5mm Edge thickness: 7.4mm AR/AR for 10.6µm (absorption <0.13%)	1pc
HG15.002/H	M78037	5.00" ZnSe Plano-convex lens High pressure lens (28bar), 50.8mm Effective focal length: 127.0mm Edge thickness: 9.7mm AR/AR for 10.6µm (absorption <0.20%)	1pc	HG15.002/HU	M78037UL	5.00" ZnSe Plan.-con. - ULTRA LOW High pressure lens (28bar), 50.8mm Effective focal length: 127.0mm Edge thickness: 9.7mm AR/AR for 10.6µm (absorption <0.13%)	1pc
HG15.003/H	M78038	7.50" ZnSe Plano-convex lens High pressure lens (28bar), 50.8mm Effective focal length: 190.5mm Edge thickness: 9.7mm AR/AR for 10.6µm (absorption <0.20%)	1pc	HG15.003/HU	M78038UL	7.50" ZnSe Plan.-con. - ULTRA LOW High pressure lens (28bar), 50.8mm Effective focal length: 190.5mm Edge thickness: 9.7mm AR/AR for 10.6µm (absorption <0.13%)	1pc
HG15.005/H	HG15.005/H	10.0" ZnSe Plano-convex lens High pressure lens (29bar), EZ-Mount TM, 50.8mm Effective focal length: 254mm Edge thickness: 9.6mm AR/AR for 10.6µm (absorption <0.20%)	1pc	HG15.015/HU	HG15.015/HU	5" ZnSe Plano-convex lens - ULTRA LOW High pressure lens (29bar), 38.1mm Effective focal length: 127.0mm Edge thickness: 7.6mm AR/AR for 10.6µm (absorption <0.13%)	1pc
HG15.015/H	HG15.015/H	5" ZnSe Plano-convex lens High pressure lens (29bar), 38.1mm Effective focal length: 127.0mm Edge thickness: 7.6mm AR/AR for 10.6µm (absorption <0.20%)	1pc	HG15.016/HU	HG15.016/HU	7.50" ZnSe Plano-convex lens - ULTRA LOW High pressure lens (29bar), 38.1mm Effective focal length: 190.5mm Edge thickness: 7.6mm AR/AR for 10.6µm (absorption <0.13%)	1pc
HG15.016/H	HG15.016/H	7.50" ZnSe Plano-convex lens High pressure lens (29bar), 38.1mm Effective focal length: 190.5mm Edge thickness: 7.8mm AR/AR for 10.6µm (absorption <0.20%)	1pc				

PROTECTION WINDOWS SUITABLE FOR AMADA®

Part No.	Ref. No.	Description	Std. Pkg.
HG17.521	HG17.521	Protection Window D33.00mm × ET = 1.50mm	1pc

ACCESSORIES SUITABLE FOR AMADA®

Part No.	Ref. No.	Description	Std. Pkg.
HG10.174	HG10.174	Polish for laser optics, 250ml, 0367432/2243066	1pc
HG10.173	HG10.173	Lens cleaning paper from TIFFEN®, sheet size 70 × 115mm	50pcs

OD ON DEMAND – WE DO NOT KEEP THESE PARTS IN STOCK, COST IS SET ACCORDING TO THE ORDERED QUANTITY, DELIVERY TIME MAY DIFFER FROM STANDARD PRODUCTS.

Last update of this page: 21/04/2022. See Revision history for details.

THERMACUT® REPLACEMENT PARTS SUITABLE FOR BYSTRONIC® BYSTRONIC® "BY" SERIES

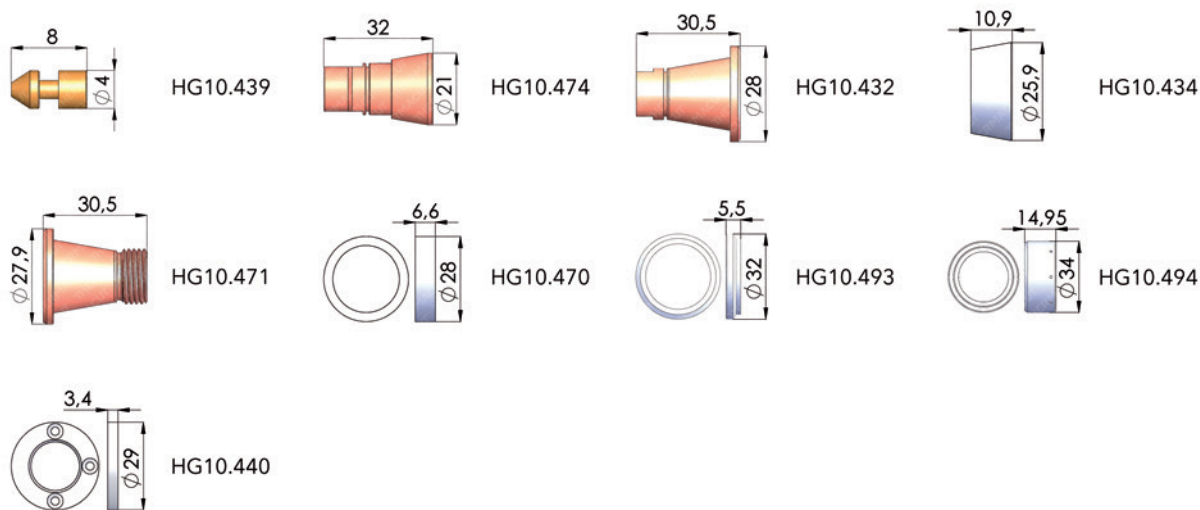

Part No.	Ref. No.	Description	Std. Pkg.	Part No.	Ref. No.	Description	Std. Pkg.
HG10.439	4-03137	Pin	1pc	HG10.472	2-08700	Shield (copper)	1pc
HG10.474	OD 3-02291	Nozzle Body	1pc	HG10.493	3-13113	Insulating Ring (small)	1pc
HG10.433	4-01642	Insulating Ring - Ceramic	1pc	HG10.495	2-10837	Nozzle Body	1pc
HG10.432	3-05497	Nozzle Body	1pc	HG10.488	10032930	Nozzle Body	1pc
HG10.434	4-01959	Conical Ceramic	1pc	HG10.494	3-13422	Insulating Ring (large)	1pc
HG10.471	2-08701	Nozzle Body	1pc	HG10.440	3-06035	Insulating Disc (PTFE)	1pc
HG10.473	3-11071	Fastener Nut	1pc	HG10.496	10055576	Nozzle Holder BySprint™	1pc
HG10.470	4-09010	Ceramic	1pc	HG10.497	10051133	Nozzle Holder BySprint™	1pc

PARTS SUITABLE FOR BYSTRONIC® "BY" SERIES

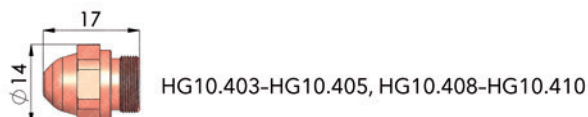

Part No.	Ref. No.	Description	Std. Pkg.	Part No.	Ref. No.	Description	Std. Pkg.
HG10.403	3-01894	Nozzle 1.00mm - 10	10pcs	HG10.411	3-01902	Nozzle 1.75mm - H17	10pcs
HG10.404	3-01895	Nozzle 1.25mm - 12	10pcs	HG10.412	3-01903	Nozzle 2.00mm - H20	10pcs
HG10.405	3-01896	Nozzle 1.50mm - 15	10pcs	HG10.413	3-01905	Nozzle 1.00mm - K10	10pcs
HG10.408	3-01899	Nozzle 1.00mm - H10	10pcs	HG10.414	OD 3-01906	Nozzle 1.25mm - K12	10pcs
HG10.409	3-01900	Nozzle 1.25mm - H12	10pcs	HG10.415	3-01907	Nozzle 1.50mm - K15	10pcs
HG10.410	3-01901	Nozzle 1.50mm - H15	10pcs				

OD ON DEMAND – WE DO NOT KEEP THESE PARTS IN STOCK, COST IS SET ACCORDING TO THE ORDERED QUANTITY, DELIVERY TIME MAY DIFFER FROM STANDARD PRODUCTS.

PolyTetraFluoroEthylene is a fluorocarbon-based polymer and is commonly abbreviated PTFE. The Teflon® brand of PTFE is manufactured only by DuPont® and is not sold by THERMACUT®. THERMACUT® purchases other brands of PTFE from various high quality manufacturers.

Last update of this page: 05/01/2024. See Revision history for details.

THERMACUT®
THE CUTTING COMPANY®

WWW.THERMACUT.COM
TEL.: +420 556 423 440
SALES@THERMACUT.CZ

THERMACUT®, THE CUTTING COMPANY®, FHT-EX®, EX-TRAFIRE®, EX-TRACK®, EX-TRABEAM® AND EX-TRAFLEAME® ARE REGISTERED TRADEMARKS OF THERMACUT, K.S. AND MAY BE REGISTERED IN CZECH REPUBLIC AND/OR OTHER COUNTRIES. ALL OTHER TRADEMARKS ARE PROPERTIES OF THEIR RESPECTIVE OWNERS. THERMACUT® IS IN NO WAY AFFILIATED WITH BYSTRONIC® AND E.I. DU PONT DE NEMOURS AND COMPANY. MOST THERMACUT® PARTS ARE MADE FOR OR BY AN IBG COMPANY.
VALID FROM MARCH 2024 • PREVIOUS VERSION IS NO LONGER VALID. • © COPYRIGHT 2024 BY THERMACUT® CZECH REPUBLIC. ALL RIGHTS RESERVED.

**THERMACUT® REPLACEMENT PARTS SUITABLE FOR
BYSTRONIC®
BYSTRONIC® "BY" SERIES**

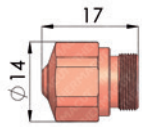

HG10.416-HG10.421
HG10.426

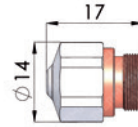

HG10.418/C
HG10.419/C
HG10.420/C

Standard copper nozzles / Standard copper nozzles with hard chromium plating

Part No.	Ref. No.	Description	Std. Pkg.	Part No.	Ref. No.	Description	Std. Pkg.
HG10.416	3-01908	Nozzle 1.75mm - K17	10pcs	HG10.421/C	3-01913CP	Nozzle 1.75mm - HK17 - HCP	10pcs
HG10.417	OD 3-01909	Nozzle 2.00mm - K20	10pcs	HG10.422	3-01914	Nozzle 2.00mm - HK20	10pcs
HG10.426	OD 3-04274	Nozzle 2.25mm - K25	10pcs	HG10.422/C	3-01914CP	Nozzle 2.00mm - HK20 - HCP	10pcs
HG10.418	3-01910	Nozzle 1.00mm - HK10	10pcs	HG10.423	3-03854	Nozzle 2.50mm - HK25	10pcs
HG10.418/C	3-01910CP	Nozzle 1.00mm - HK10 - HCP	10pcs	HG10.425	3-06112	Nozzle 3.00mm - HK30	10pcs
HG10.419	3-01911	Nozzle 1.25mm - HK12	10pcs	HG10.424	HG10.424	Nozzle 3.50mm - HK35	10pcs
HG10.419/C	3-01911CP	Nozzle 1.25mm - HK12 - HCP	10pcs	HG10.500	10071494	Nozzle Holder	1pc
HG10.420	3-01912	Nozzle 1.50mm - HK15	10pcs	HG11.340	10075057	Breakaway	10pcs
HG10.420/C	3-01912CP	Nozzle 1.50mm - HK15 - HCP	10pcs				
HG10.421	3-01913	Nozzle 1.75mm - HK17	10pcs				

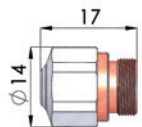

HG10.428/D
HG10.429/D
HG10.431/D-HG10.434/D

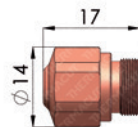

HG10.430/D
HG10.433/A
HG10.435/D
HG10.435/A

Standard double copper nozzles / Standard double copper nozzles with hard chromium plating

Part No.	Ref. No.	Description	Std. Pkg.	Part No.	Ref. No.	Description	Std. Pkg.
HG10.428/D	3-16058	Nozzle 1.00mm - NK10	10pcs	HG10.418/D	3-16058CP	Nozzle 1.00mm - NK10 - HCP	10pcs
HG10.429/D	3-16059	Nozzle 1.20mm - NK12	10pcs	HG10.419/D	3-16059CP	Nozzle 1.20mm - NK12 - HCP	10pcs
HG10.430/D	3-16060	Nozzle 1.50mm - NK15	10pcs	HG10.420/D	3-16060CP	Nozzle 1.50mm - NK15 - HCP	10pcs
HG10.431/D	3-14317	Nozzle 1.70mm - NK17	10pcs	HG10.421/D	3-14317CP	Nozzle 1.70mm - NK17 - HCP	10pcs
HG10.432/D	3-14318	Nozzle 2.00mm - NK20	10pcs	HG10.423/D	3-14319CP	Nozzle 2.50mm - NK25 - HCP	10pcs
HG10.433/D	3-14319	Nozzle 2.50mm - NK25	10pcs	HG10.423/A OD	3-16256CP	Nozzle 2.50mm - NK25 - AL - HCP	10pcs
HG10.433/A	3-16256	Nozzle 2.50mm - NK25 - AL	10pcs	HG10.425/D	3-16061CP	Nozzle 3.00mm - NK30 - HCP	10pcs
HG10.435/D	3-16061	Nozzle 3.00mm - NK30	10pcs	HG10.425/A	3-16257CP	Nozzle 3.00mm - NK30 - AL - HCP	10pcs
HG10.435/A	3-16257	Nozzle 3.00mm - NK30 - AL	10pcs	HG10.424/D	HG10.434DCP	Nozzle 3.50mm - NK35 - HCP	10pcs
HG10.434/D	HG10.434D	Nozzle 3.50mm - NK35	10pcs				

OD ON DEMAND – WE DO NOT KEEP THESE PARTS IN STOCK, COST IS SET ACCORDING TO THE ORDERED QUANTITY, DELIVERY TIME MAY DIFFER FROM STANDARD PRODUCTS.

Last update of this page: 05/05/2023. See Revision history for details.

THERMACUT® REPLACEMENT PARTS SUITABLE FOR BYSTRONIC® BYSTRONIC® HK/NK SERIES - COPPER

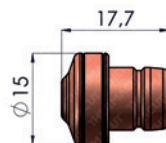
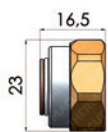

Part No.	Ref. No.	Description	Std. Pkg.	Part No.	Ref. No.	Description	Std. Pkg.
HG12.341	10077009	Nozzle Holder	1pc	HG11.353	10035275	Double Nozzle 1.2mm - NK12-15	10pcs
HG12.342	10074594	Nozzle Holder	1pc	HG11.354	10035278	Double Nozzle 1.5mm - NK15-15	10pcs
HG11.340	10075057	Breakaway	10pcs	HG11.355	10035290	Double Nozzle 1.7mm - NK17-15	10pcs
HG11.343	10048529	Nozzle 0.8mm - HK8	10pcs	HG11.356	10035292	Double Nozzle 2.0mm - NK20-15	10pcs
HG11.344	10035266	Nozzle 1.0mm - HK10	10pcs	HG11.357	10035294	Double Nozzle 2.5mm - NK25-15	10pcs
HG11.345	10035267	Nozzle 1.2mm - HK12	10pcs	HG11.358	10035296	Double Nozzle 2.5mm - NK25-20	10pcs
HG11.346	10035268	Nozzle 1.5mm - HK15	10pcs	HG11.359	10035298	Double Nozzle 3.0mm - NK30-17	10pcs
HG11.347	10035269	Nozzle 1.7mm - HK17	10pcs	HG11.360	10035301	Double Nozzle 3.0mm - NK30-20	10pcs
HG11.348	10035270	Nozzle 2.0mm - HK20	10pcs	HG11.361	10068496	Double Nozzle 3.5mm - NK35-17	10pcs
HG11.349	10035271	Nozzle 2.5mm - HK25	10pcs				
HG11.350	10035272	Nozzle 3.0mm - HK30	10pcs				
HG11.352	10049747	Double Nozzle 1.0mm - NK10-15	10pcs				

PARTS SUITABLE FOR BYSTRONIC® HK/NK SERIES - BRASS



Part No.	Ref. No.	Description	Std. Pkg.	Part No.	Ref. No.	Description	Std. Pkg.
HG12.339	10114605	Nozzle Holder Precision™	1pc	HG11.440	10097531	Double Nozzle 1.5mm - NK15-15	10pcs
HG11.340	10075057	Breakaway	10pcs	HG11.441	10097533	Double Nozzle 1.7mm - NK17-15	10pcs
HG11.430	10097507	Nozzle 1.0mm - HK10	10pcs	HG11.450	10119813	Double Nozzle 1.7mm - NK17-17	10pcs
HG11.431	10097508	Nozzle 1.2mm - HK12	10pcs	HG11.442	10097534	Double Nozzle 2.0mm - NK20-15	10pcs
HG11.432	10097509	Nozzle 1.5mm - HK15	10pcs	HG11.443	10097537	Double Nozzle 2.5mm - NK25-15	10pcs
HG11.433	10097510	Nozzle 1.7mm - HK17	10pcs	HG11.444	10097549	Double Nozzle 2.5mm - NK25-20	10pcs
HG11.434	10097511	Nozzle 2.0mm - HK20	10pcs	HG11.445	10097543	Double Nozzle 3.0mm - NK30-17	10pcs
HG11.435	10097512	Nozzle 2.5mm - HK25	10pcs	HG11.446	10097551	Double Nozzle 3.0mm - NK30-20	10pcs
HG11.436	10097513	Nozzle 3.0mm - HK30	10pcs	HG11.447	10097553	Double Nozzle 3.5mm - NK35-17	10pcs
HG11.437	10097514	Nozzle 3.5mm - HK35	10pcs	HG11.448	10097552	Double Nozzle 3.5mm - NK35-30	10pcs
HG11.438	10097525	Double Nozzle 1.0mm - NK10-15	10pcs	HG11.449	10097554	Double Nozzle 4.0mm - NK40-17	10pcs
HG11.439	10097528	Double Nozzle 1.2mm - NK12-15	10pcs				

Last update of this page: 29/03/2024. See Revision history for details.

THERMACUT®
THE CUTTING COMPANY®

WWW.THERMACUT.COM
TEL.: +420 556 423 440
SALES@THERMACUT.CZ

THERMACUT®, THE CUTTING COMPANY®, FHT-EX®, EX-TRAFIRE®, EX-TRACK®, EX-TRABEAM® AND EX-TRAFLEAME® ARE REGISTERED TRADEMARKS OF THERMACUT, K.S. AND MAY BE REGISTERED IN CZECH REPUBLIC AND/OR OTHER COUNTRIES. ALL OTHER TRADEMARKS ARE PROPERTIES OF THEIR RESPECTIVE OWNERS. THERMACUT® IS IN NO WAY AFFILIATED WITH BYSTRONIC®. MOST THERMACUT® PARTS ARE MADE FOR OR BY AN IBG COMPANY.
VALID FROM MARCH 2024 • PREVIOUS VERSION IS NO LONGER VALID. • © COPYRIGHT 2024 BY THERMACUT® CZECH REPUBLIC. ALL RIGHTS RESERVED.

THERMACUT® REPLACEMENT PARTS SUITABLE FOR BYSTRONIC® LENSES SUITABLE FOR BYSTRONIC®



Part No.	Ref. No.	Description	Std. Pkg.	Part No.	Ref. No.	Description	Std. Pkg.
HG10.731/H	4-00186	5.00" ZnSe Meniscus lens High pressure lens (20bar), 38.1mm Effective focal length: 127.0mm Edge thickness: 6.0mm AR/AR for 10.6µm (absorption <0.20%)	1pc	HG10.733/H	4-05094	5.00" ZnSe Meniscus lens High pressure lens (42bar), 38.1mm Effective focal length: 127.0mm Edge thickness: 9.0mm AR/AR for 10.6µm (absorption <0.20%)	1pc
HG10.732/H	4-00187	7.50" ZnSe Meniscus lens High pressure lens (20bar), 38.1mm Effective focal length: 190.5mm Edge thickness: 6.0mm AR/AR for 10.6µm (absorption <0.20%)	1pc	HG10.734/H	4-05095	7.50" ZnSe Meniscus lens High pressure lens (42bar), 38.1mm Effective focal length: 190.5mm Edge thickness: 9.0mm AR/AR for 10.6µm (absorption <0.20%)	1pc
HG10.729/H	4-10736	3.75" ZnSe Meniscus lens High pressure lens (42bar), 38.1mm Effective focal length: 95.3mm Edge thickness: 9.0mm AR/AR for 10.6µm (absorption <0.20%)	1pc	HG10.733/HU	4-07475	5.00" ZnSe Meniscus lens - ULTRA LOW High pressure lens (42bar), 38.1mm Effective focal length: 127.0mm Edge thickness: 9.0mm AR/AR for 10.6µm (absorption <0.13%)	1pc
				HG10.734/HU	4-07476	7.50" ZnSe Meniscus lens - ULTRA LOW High pressure lens (42bar), 38.1mm Effective focal length: 190.5mm Edge thickness: 9.0mm AR/AR for 10.6µm (absorption <0.13%)	1pc

PROTECTION WINDOWS SUITABLE FOR BYSTRONIC®

Part No.	Ref. No.	Description	Std. Pkg.
HG17.517	10045746	Protection Window D36.00mm × ET = 5.0mm	1pc
HG11.599	10086368	Protection Window 34x3, Saphire	1pc

ACCESSORIES SUITABLE FOR BYSTRONIC®

Part No.	Ref. No.	Description	Std. Pkg.
HG10.174	HG10.174	Polish for laser optics, 250ml, 0367432/2243066	1pc
HG10.173	HG10.173	Lens cleaning paper from TIFFEN®, sheet size 70 × 115mm	50pcs
HG15.136	OD HG15.136	Latex gloves	100pcs

AIR FILTERS SUITABLE FOR BYSTRONIC®

Part No.	Ref. No.	Description	Std. Pkg.
HG10.176	OD HG10.176	Air filter for cooling aggregate size: 800 × 600 × 8mm	25pcs

OD ON DEMAND – WE DO NOT KEEP THESE PARTS IN STOCK, COST IS SET ACCORDING TO THE ORDERED QUANTITY, DELIVERY TIME MAY DIFFER FROM STANDARD PRODUCTS.

Last update of this page: 05/05/2023. See Revision history for details.

THERMACUT® REPLACEMENT PARTS SUITABLE FOR CINCINNATI®



Part No.	Ref. No.	Description	Std. Pkg.	Part No.	Ref. No.	Description	Std. Pkg.
HG12.008	OD 963021	Tip Retainer Nut	1pc	HG12.019	923014	Nozzle 1.5mm (0.060")	10pcs
HG12.012	OD 924635-1	Nozzle 1.0mm (0.040")	10pcs	HG12.020	924636	Nozzle 1.5mm (0.060")	10pcs
HG12.013	909660	Nozzle 1.5mm (0.060")	10pcs	HG12.021	924637	Nozzle 2.0mm (0.080")	10pcs
HG12.014	OD 910315	Nozzle 2.0mm (0.080")	10pcs	HG12.041	PLGJT0256	Nozzle Double Blunt 1.0mm	10pcs
HG12.015	924638	Nozzle 2.5mm (0.100")	10pcs	HG12.042	PLGJT0257	Nozzle Double Blunt 1.5mm	10pcs
HG12.016	924634	Nozzle 3.0mm (0.120")	10pcs	HG12.040	PLGJT0718	Nozzle Double Blunt 1.5-2.0mm	10pcs

PROTECTION WINDOWS SUITABLE FOR CINCINNATI®

Part No.	Ref. No.	Description	Std. Pkg.
HG12.036	HG12.036	Protection Window D38.10mm × ET = 1.6mm	1pc
HG12.037	HG12.037	Protection Window D38.10mm × ET = 6.0mm	1pc

OD ON DEMAND – WE DO NOT KEEP THESE PARTS IN STOCK, COST IS SET ACCORDING TO THE ORDERED QUANTITY, DELIVERY TIME MAY DIFFER FROM STANDARD PRODUCTS.

Last update of this page: 05/01/2024. See Revision history for details.

THERMACUT® REPLACEMENT PARTS SUITABLE FOR MAZAK®

MAZAK® XT510 HI-PRO™, NTX48™, TURBO 10KW™, SUPER TURBO 15KW™, SUPER TURBO 20KW HI-PRO™, SUPER TURBO X510 HI-PRO™

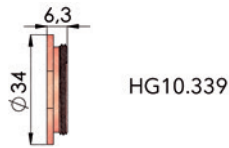

HG10.339

Part No.	Ref. No.	Description	Std. Pkg.	Part No.	Ref. No.	Description	Std. Pkg.
HG10.339	46683301100	Bracket	1pc	HG10.353	HG10.353	Complete Nozzle Holder	1pc
HG10.347	46683301160	Ring	1pc				

SUITABLE FOR

MAZAK® LASER CNC L32 PLUS SUPER CHARGE™, XT510™, NTX48™, TURBO 10KW™, SUPER TURBO 15KW™, SUPER TURBO 20KW HI-PRO™, SUPER TURBO X510 HI-PRO™

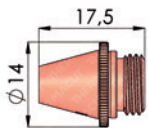

HG10.309
HG10.310
HG10.318

Adapter copper nozzles

Part No.	Ref. No.	Description	Std. Pkg.	Part No.	Ref. No.	Description	Std. Pkg.
HG10.309	46603350512K	Adapter Nozzle 1.2mm	10pcs	HG10.477	46603350512H	Adapter-6-edgenozzle 1.2mm	10pcs
HG10.310	46603350515K	Adapter Nozzle 1.5mm	10pcs				
HG10.318	46603350520K	Adapter Nozzle 2.0mm	10pcs				
HG10.308	46603350525K	Adapter Nozzle 2.5mm	10pcs				

SUITABLE FOR

MAZAK® 5" C/MG, MAZAK® 5" H/MG

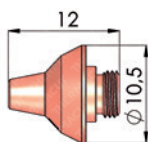

HG10.287-HG10.290
HG10.487

Part No.	Ref. No.	Description	Std. Pkg.	Part No.	Ref. No.	Description	Std. Pkg.
HG10.287	46713300290-12	Nozzle 1.2mm 3D (P0352-384-00012)	1pc	HG10.295	46713300300	Nozzle 2.0mm 2D (P0352-387-00020)	1pc
HG10.288	46713300290-15	Nozzle 1.5mm 3D (P0352-381-00015)	1pc	HG10.296	46713300300-25	Nozzle 2.5mm 2D	1pc
HG10.290	46713300310-2.0	Nozzle 2.0mm 3D (P0352-382-00020)	1pc	HG10.297	46713300300-30	Nozzle 3.0mm 2D	1pc
HG10.487	46713300280-30	Nozzle 3.0mm 3D	1pc				

Last update of this page: 27/06/2022. See Revision history for details.

THERMACUT®
THE CUTTING COMPANY®

WWW.THERMACUT.COM
TEL.: +420 556 423 440
SALES@THERMACUT.CZ

THERMACUT®, THE CUTTING COMPANY®, FHT-EX®, EX-TRAFIRE®, EX-TRACK®, EX-TRABEAM® AND EX-TRAFLEAME® ARE REGISTERED TRADEMARKS OF THERMACUT, K.S. AND MAY BE REGISTERED IN CZECH REPUBLIC AND/OR OTHER COUNTRIES. ALL OTHER TRADEMARKS ARE PROPERTIES OF THEIR RESPECTIVE OWNERS. THERMACUT® IS IN NO WAY AFFILIATED WITH MAZAK®. MOST THERMACUT® PARTS ARE MADE FOR OR BY AN IBG COMPANY.

VALID FROM MARCH 2024 • PREVIOUS VERSION IS NO LONGER VALID. • © COPYRIGHT 2024 BY THERMACUT® CZECH REPUBLIC. ALL RIGHTS RESERVED.

**THERMACUT® REPLACEMENT PARTS SUITABLE FOR
MAZAK®
SUITABLE FOR HYPER GEAR NTX510™**

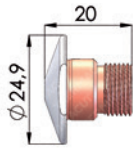

HG10.670-HG10.673

Part No.	Ref. No.	Description	Std. Pkg.	Part No.	Ref. No.	Description	Std. Pkg.
HG10.670	46143304470	Nozzle 1.2mm HCP	10pcs	HG10.672	46143304460	Nozzle 2.0mm HCP	10pcs
HG10.671	46143304450	Nozzle 1.5mm HCP	10pcs	HG10.673	46143304480	Nozzle 2.5mm HCP	10pcs

**THERMACUT® REPLACEMENT PARTS SUITABLE FOR
MAZAK®**

Part No.	Ref. No.	Description	Std. Pkg.	Part No.	Ref. No.	Description	Std. Pkg.
HG10.629	36143304420	Nozzle Holder Hyper Gear	1pc	HG10.645	46143300290	Retainer Nut	1pc
HG10.638	46143308170	Spacer	1pc	HG10.646 OD	46143300260	Insulator - PTFE	1pc
HG10.639 OD	46143308190	Connector	1pc	HG10.647 OD	46143300270	Insulator - PTFE	1pc
HG10.640	46143300240	Insulator - PTFE	1pc	HG10.648	46143300280	Retainer Nut	1pc
HG10.641	46143304250	Retainer Nut	1pc	HG10.649	46143300320	Ring - Brass	1pc
HG10.642 OD	46143307420	Retainer Nut	1pc	HG10.686		Complete Head (PTFE Spacer)	1pc
HG10.643 OD	46683301180	Screw	1pc	HG10.687		Complete Head (PTFE Spacer)	1pc
HG10.644	46143304440	Insulator - PTFE	1pc				

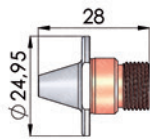

HG10.691-HG10.697

Part No.	Ref. No.	Description	Std. Pkg.	Part No.	Ref. No.	Description	Std. Pkg.
HG10.691	46143310341	Nozzle 1.2mm Slim CP	10pcs	HG10.697	46143310381	Nozzle 3.0mm Slim CP	10pcs
HG10.692	46143310351	Nozzle 1.5mm Slim CP	10pcs				
HG10.694	46143310361	Nozzle 2.0mm Slim CP	10pcs				
HG10.696	46143310371	Nozzle 2.5mm Slim CP	10pcs				

OD ON DEMAND – WE DO NOT KEEP THESE PARTS IN STOCK, COST IS SET ACCORDING TO THE ORDERED QUANTITY, DELIVERY TIME MAY DIFFER FROM STANDARD PRODUCTS.

PolyTetraFluoroEthylene is a fluorocarbon-based polymer and is commonly abbreviated PTFE. The Teflon® brand of PTFE is manufactured only by DuPont® and is not sold by THERMACUT®. THERMACUT® purchases other brands of PTFE from various high quality manufacturers.

Last update of this page: 23/02/2023. See Revision history for details.

THERMACUT® REPLACEMENT PARTS SUITABLE FOR MAZAK®

LENSES SUITABLE FOR MAZAK®



Part No.	Ref. No.	Description	Std. Pkg.	Part No.	Ref. No.	Description	Std. Pkg.
HG10.167/H	HG10.167/H	5.00" ZnSe Meniscus lens High pressure lens (29bar), 38.1mm Effective focal length: 127.0mm Edge thickness: 7.4mm AR/AR for 10.6µm (absorption <0.20%)	1pc	HG15.016/H	HG15.016/H	7.50" ZnSe Plano-convex lens High pressure lens (29bar), 38.1mm Effective focal length: 190.5mm Edge thickness: 7.6mm AR/AR for 10.6µm (absorption <0.20%)	1pc
HG15.015/H	HG15.015/H	5.00" ZnSe Plano-convex lens High pressure lens (28bar), 38.1mm Effective focal length: 127.0mm Edge thickness: 7.6mm AR/AR for 10.6µm (absorption <0.20%)	1pc	HG10.621/H	HG10.621/H	7.50" ZnSe Meniscus lens High pressure lens (28bar), 50.8mm Effective focal length: 190.5mm Edge thickness: 9.7mm AR/AR for 10.6µm (absorption <0.20%)	1pc
HG15.024/H ^{OD}	HG15.024/H	5.00" ZnSe Plano-convex lens High pressure lens (33bar), 38.1mm Effective focal length: 127.0mm Edge thickness: 7.87mm AR/AR for 10.6µm (absorption <0.20%)	1pc	HG15.028/H	HG15.028/H	7.50" ZnSe Plano-convex lens High pressure lens (19bar), 50.8mm Effective focal length: 190.5mm Edge thickness: 7.87mm AR/AR for 10.6µm (absorption <0.20%)	1pc
HG15.002/H	HG15.002/H	5.00" ZnSe Plano-convex lens High pressure lens (28bar), 50.8mm Effective focal length: 127.0mm Edge thickness: 9.7mm AR/AR for 10.6µm (absorption <0.20%)	1pc	HG15.003/H	HG15.003/H	7.50" ZnSe Plano-convex lens High pressure lens (28bar), 50.8mm Effective focal length: 190.5mm Edge thickness: 9.7mm AR/AR for 10.6µm (absorption <0.20%)	1pc
HG10.168/H	HG10.168/H	7.50" ZnSe Meniscus lens High pressure lens (29bar), 38.1mm Effective focal length: 190.5mm Edge thickness: 7.4mm AR/AR for 10.6µm (absorption <0.20%)	1pc	HG10.167/HU	HG10.167/HU	5.00" ZnSe Men. lens - ULTRA LOW High pressure lens (29bar), 38.1mm Effective focal length: 127.0mm Edge thickness: 7.4mm AR/AR for 10.6µm (absorption <0.13%)	1pc
				HG10.168/HU	HG10.168/HU	7.50" ZnSe Men. lens - ULTRA LOW High pressure lens (29bar), 38.1mm Effective focal length: 190.5mm Edge thickness: 7.4mm AR/AR for 10.6µm (absorption <0.13%)	1pc

ACCESSORIES SUITABLE FOR MAZAK®

Part No.	Ref. No.	Description	Std. Pkg.
HG10.174	HG10.174	Polish for laser optics, 250ml, 0367432/2243066	1pc
HG10.173	HG10.173	Lens cleaning paper from TIFFEN®, sheet size 70 × 115mm	50pcs

^{OD} ON DEMAND – WE DO NOT KEEP THESE PARTS IN STOCK, COST IS SET ACCORDING TO THE ORDERED QUANTITY, DELIVERY TIME MAY DIFFER FROM STANDARD PRODUCTS.

Last update of this page: 05/01/2024. See Revision history for details.

FOR US MARKET ONLY

THERMACUT® REPLACEMENT PARTS SUITABLE FOR MAZAK®

MAZAK® LASER CNC L32 PLUS SUPER CHARGE™, XT510™, NTX48™, TURBO 10KW™, SUPER TURBO 15KW™, SUPER TURBO 20KW HI-PRO™, SUPER TURBO X510 HI-PRO™

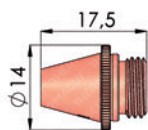

HG10.309
HG10.310
HG10.318

Adapter copper nozzles

Part No.	Ref. No.	Description	Std. Pkg.	Part No.	Ref. No.	Description	Std. Pkg.
HG10.309	46603350512K	Adapter Nozzle 1.2mm	10pcs	HG10.477-LS	46603350512H	Adapter-6-edgenozzle 1.2mm	10pcs
HG10.310	46603350515K	Adapter Nozzle 1.5mm	10pcs	HG10.479-LS	46603350517H	Adapter-6-edgenozzle 1.7mm	10pcs
HG10.318	46603350520K	Adapter Nozzle 2.0mm	10pcs	HG10.481-LS	46603350525H	Adapter-6-edgenozzle 2.5mm	10pcs
HG10.308	46603350525K	Adapter Nozzle 2.5mm	10pcs	HG10.482-LS	46603350530H	Adapter-6-edgenozzle 3.0mm	10pcs
HG10.475-LS	46603350508H	Adapter-6-edgenozzle 0.8mm	10pcs				
HG10.476-LS	46603350511H	Adapter-6-edgenozzle 1.0mm	10pcs				

Last update of this page: 27/06/2022. See Revision history for details.

THERMACUT®
THE CUTTING COMPANY®

WWW.THERMACUT.COM
TEL.: +420 556 423 440
SALES@THERMACUT.CZ

THERMACUT®, THE CUTTING COMPANY®, FHT-EX®, EX-TRAFIRE®, EX-TRACK®, EX-TRABEAM® AND EX-TRAFLEAME® ARE REGISTERED TRADEMARKS OF THERMACUT, K.S. AND MAY BE REGISTERED IN CZECH REPUBLIC AND/OR OTHER COUNTRIES. ALL OTHER TRADEMARKS ARE PROPERTIES OF THEIR RESPECTIVE OWNERS. THERMACUT® IS IN NO WAY AFFILIATED WITH MAZAK®. MOST THERMACUT® PARTS ARE MADE FOR OR BY AN IBG COMPANY.
VALID FROM MARCH 2024 • PREVIOUS VERSION IS NO LONGER VALID. • © COPYRIGHT 2024 BY THERMACUT® CZECH REPUBLIC. ALL RIGHTS RESERVED.

FOR US MARKET ONLY
THERMACUT® REPLACEMENT PARTS SUITABLE FOR
MAZAK®
MAZAK® 5" C/MG, MAZAK® 5" H/MG

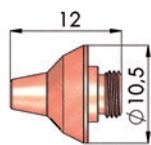

HG10.287-HG10.290
 HG10.487

Part No.	Ref. No.	Description	Std. Pkg.	Part No.	Ref. No.	Description	Std. Pkg.
HG10.287	46713300290-12	Nozzle 1.2mm 3D (P0352-384-00012)	1pc	HG10.295	46713300300	Nozzle 2.0mm 2D (P0352-387-00020)	1pc
HG10.288	46713300290-15	Nozzle 1.5mm 3D (P0352-381-00015)	1pc	HG10.296	46713300300-25	Nozzle 2.5mm 2D	1pc
HG10.290	46713300310-2.0	Nozzle 2.0mm 3D (P0352-382-00020)	1pc	HG10.297	46713300300-30	Nozzle 3.0mm 2D	1pc
HG10.486-LS	46713300280-25	Nozzle 2.5mm 3D (P0352-385-00025)	1pc	HG13.238-LS	36143312220	Nozzle Pencil 1.2mm CP	1pc
HG10.487-LS	46713300280-30	Nozzle 3.0mm 3D	1pc	HG13.240-LS	Q6143300060	Nozzle pencil 1.8mm CP	1pc
HG10.263-LS	46713300290-18	Nozzle 1.8mm 3D	1pc	HG13.241-LS	36143312240	Nozzle Pencil 2.0mm CP	1pc
HG10.264-LS	46713300280-20	Nozzle 2.0mm 3D	1pc	HG13.243-LS	36143312260	Nozzle Pencil 3.0mm CP	1pc
HG10.265-LS	46713300280-35	Nozzle 3.5mm 3D	1pc	HG13.244-LS	36143312270	Nozzle Pencil 3.5mm CP	1pc
HG13.246-LS	06143355590	Nozzle Pencil 4.5mm CP	1pc	HG13.245-LS	36143312280	Nozzle Pencil 4.0mm CP	1pc
HG10.292-LS	46713300310-1.2	Nozzle 1.2mm 2D	1pc				

FOR US MARKET ONLY
SUITABLE FOR HYPER GEAR NTX510™

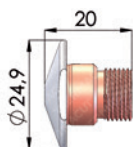

HG10.670-HG10.673

Part No.	Ref. No.	Description	Std. Pkg.	Part No.	Ref. No.	Description	Std. Pkg.
HG10.670	46143304470	Nozzle 1.2mm HCP	10pcs	HG13.202-LS	46603350530 4.0	Nozzle 4.0mm	10pcs
HG10.671-LS	46143304450	Nozzle 1.5mm HCP	10pcs	HG13.203-LS	46603350530 4.5	Nozzle 4.5mm	10pcs
HG10.672	46143304460	Nozzle 2.0mm HCP	10pcs	HG13.204-LS	46603350530-5.0	Nozzle 5.0mm	10pcs
HG10.673-LS	46143304480	Nozzle 2.5mm HCP	10pcs	HG13.248-LS	Q6143300080	Double Nozzle Pencil 1.2mm CP	10pcs
HG10.674-LS	46143304490	Nozzle 3.0mm HCP	10pcs	HG13.249-LS	36143312300	Double Nozzle Pencil 1.5mm CP	10pcs
HG10.675-LS	46143304500	Nozzle 3.5mm HCP	10pcs	HG10.286-LS	46713300290-10	Nozzle 1.0mm 3D	10pcs
HG10.676-LS	46143304510	Nozzle 4.0mm HCP	10pcs	HG13.206-LS	Q6713330410	Nozzle 1.2mm 3D	10pcs
HG13.201-LS	46603350530 -3.5	Nozzle 3.5mm	10pcs				

Last update of this page: 27/06/2022. See Revision history for details.

FOR US MARKET ONLY

THERMACUT® REPLACEMENT PARTS SUITABLE FOR MAZAK®

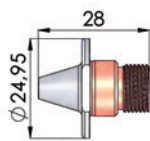

HG10.691–HG10.697

Part No.	Ref. No.	Description	Std. Pkg.	Part No.	Ref. No.	Description	Std. Pkg.
HG10.691	46143310341	Nozzle 1.2mm Slim CP	10pcs	HG10.708-LS	46603350520-1.5	Nozzle 1.5mm	10pcs
HG10.692	46143310351	Nozzle 1.5mm Slim CP	10pcs	HG10.709-LS	46603350521-1.7	Nozzle 1.7mm	10pcs
HG10.694	46143310361	Nozzle 2.0mm Slim CP	10pcs	HG10.710-LS	46603350522-2.0	Nozzle 2.0mm	10pcs
HG10.696	46143310371	Nozzle 2.5mm Slim CP	10pcs	HG10.711-LS	46603350522-2.5	Nozzle 2.5mm	10pcs
HG10.697	46143310381	Nozzle 3.0mm Slim CP	10pcs	HG13.262-LS	4660335052C	Nozzle 2.0mm CP	10pcs
HG13.223-LS	46143310373	Nozzle Slim 2.5mm CP	10pcs	HG13.200-LS	4660335052B	Nozzle 1.5mm	10pcs
HG13.222-LS	46143310363	Nozzle Slim 2.0mm CP	10pcs	HG13.236-LS	06283301190	Nozzle Pencil 1.0mm CP	10pcs
HG13.225-LS	46143310403	Nozzle Slim 4.0mm CP	10pcs	HG13.239-LS	36143312230	Nozzle Pencil 1.5mm CP	10pcs
HG13.224-LS	46143310393	Nozzle Slim 3.5mm CP	10pcs	HG13.242-LS	36143312250	Nozzle Pencil 2.5mm CP	10pcs
HG13.247-LS	06143355600	Nozzle Pencil 5.5mm CP	10pcs	HG13.237-LS	06283301030	Nozzle Pencil 5.0mm CP	10pcs
HG13.207-LS	46683302420	Double Nozzle 1.5mm	10pcs	HG13.258-LS	6283301790	Nozzle Pencil 1.0mm HP/CP	10pcs
HG13.218-LS	46143306450	Double Nozzle 1.5mm CP	10pcs	HG13.259-LS	6283301800	Nozzle Pencil 1.2mm HP/CP	10pcs
HG13.211-LS	46683302420	Double Nozzle 1.5mm CP	10pcs	HG13.260-LS	6283301810	Nozzle Pencil 1.5mm HP/CP	10pcs
HG13.208-LS	46683302430	Double Nozzle 2.0mm	10pcs	HG13.261-LS	6283301820	Double Nozzle Pencil 1.0mm HP/CP	10pcs
HG13.219-LS	46143306460	Double Nozzle 2.0mm CP	10pcs	HG13.250-LS	36143312310	Double Nozzle Pencil 1.8mm CP	10pcs
HG13.212-LS	46683302430	Double Nozzle 2.0mm CP	10pcs	HG13.252-LS	36143312320	Double Nozzle Pencil 2.5mm CP	10pcs
HG13.213-LS	46683302440	Double Nozzle 2.5mm	10pcs	HG13.253-LS	36143312330	Double Nozzle Pencil 3.0mm CP	10pcs
HG13.220-LS	46143306480	Double Nozzle 2.5mm CP	10pcs	HG13.254-LS	36143312340	Double Nozzle Pencil 3.5mm CP	10pcs
HG13.210-LS	46683302450	Double Nozzle 3.0mm	10pcs	HG13.255-LS	36143312350	Double Nozzle Pencil 4.0mm CP	10pcs
HG13.214-LS	46683302450	Double Nozzle 3.0mm CP	10pcs	HG13.256-LS	Q6143312360	Double Nozzle Pencil 4.5mm CP	10pcs
HG13.221-LS	46143306500	Double Nozzle 3.5mm CP	10pcs	HG13.257-LS	Q6143312370	Double Nozzle Pencil 5.0mm CP	10pcs
HG13.215-LS	Q6283300030	Double Nozzle Smooth 6.0mm	10pcs	HG13.205-LS	46603350522-2.2	Nozzle 2.2mm	10pcs
HG13.216-LS	Q6283300020	Double Nozzle Smooth 7.5mm	10pcs	HG13.226-LS	46683301281-2.5	Nozzle 2.5mm	10pcs
HG13.217-LS	Q6283300010	Double Nozzle Smooth 9.5mm	10pcs	HG13.227-LS	46143310343	Nozzle Slim 1.2mm CP	10pcs
HG10.681-LS	46143306490	Double Nozzle 3.0mm Hard CP	10pcs	HG13.228-LS	46143310353	Nozzle Slim 1.5mm CP	10pcs
HG10.692D-LS	36143311500	Nozzle 1.5mm Slim Double CP	10pcs	HG13.231-LS	46143310383	Nozzle Slim 3.0mm CP	10pcs
HG10.694D-LS	36143311510	Nozzle 2.0mm Slim Double CP	10pcs	HG13.233-LS	46143310402	Nozzle Slim 4.0mm CP	10pcs
HG10.696D-LS	36143311520	Nozzle 2.5mm Slim Double CP	10pcs	HG13.234-LS	36143312380	Nozzle 3.5mm Slim Double CP	10pcs
HG10.697D-LS	36143311530	Nozzle 3.0mm Slim Double CP	10pcs	HG13.235-LS	36143312390	Nozzle 4.0mm Slim Double CP	10pcs
HG10.705-LS	46603350521-0.8	Nozzle 0.8mm	10pcs				
HG10.706-LS	46603350521-1.0	Nozzle 1.0mm	10pcs				
HG10.707-LS	46603350521-1.2	Nozzle 1.2mm	10pcs				

Last update of this page: 27/06/2022. See Revision history for details.

FOR US MARKET ONLY

THERMACUT® REPLACEMENT PARTS SUITABLE FOR MAZAK®

Part No.	Ref. No.	Description	Std. Pkg.	Part No.	Ref. No.	Description	Std. Pkg.
HG10.629-LS	36143304420	Nozzle Holder Hyper Gear	1pc	HG10.642	46143307420	Retainer Nut	1pc
HG10.630-LS	36143304400	Coupler	1pc	HG10.643-LS	46683301180	Screw	1pc
HG10.631-LS	46143300230	Replacement Ball Kit (6pcs)	1pc	HG10.644-LS	46143304440	Insulator - PTFE	1pc
HG10.632	46143304430	Spring Retainer	1pc	HG10.645-LS	46143300290	Retainer Nut	1pc
HG10.633-LS	46143308000	Spring Retainer - Steel	1pc	HG10.646-LS	46143300260	Insulator - PTFE	1pc
HG10.634-LS	46143300220	Spring	1pc	HG10.647-LS	46143300270	Insulator - PTFE	1pc
HG10.635-LS	36143303242	Body	1pc	HG10.648	46143300280	Retainer Nut	1pc
HG10.636-LS	36143307980	Aluminium Body	1pc	HG10.649-LS	46143300320	Ring - Brass	1pc
HG10.638-LS	46143308170	Spacer	1pc	HG10.667-LS	36143300332	Ring - Aluminum	1pc
HG10.639-LS	46143308190	Connector	1pc	HG10.686		Complete Head (PTFE Spacer)	1pc
HG10.640-LS	46143300240	Insulator - PTFE	1pc	HG10.687		Complete Head (PTFE Spacer)	1pc
HG10.641	46143304250	Retainer Nut	1pc	HG10.335-LS	46683301070	Base	1pc
HG10.345-LS	46683301140	Housing	1pc	HG13.424-LS	J2600S03200	O-Ring External Base - rubber	1pc
HG10.337	46683300032	Screw M5x0.5	1pc	HG13.430-LS	36143310550	Aluminum Body	1pc
HG10.433	36143310530	H.G. Coupler	1pc	HG13.423-LS	46602350080	Stylus Foot H9 Brass	1pc
HG13.400-LS	46683301920	Cover Clips PTFE	1pc	HG10.332-LS	46683301110	Bracket	1pc
HG13.427-LS	46683301171	Connector Assembly	1pc	HG10.339-LS	46683301100	Bracket	1pc
HG10.341-LS	46683300850	Nozzle Holder	1pc	HG10.343-LS	46683300000	Screw M2.5x4	1pc
HG10.347-LS	46683301160	Ring	1pc	HG10.346-LS	46683301150	PTFE Spacer 17x1.5	1pc
HG10.350-LS	46683301870	Cover Clips PTFE	1pc	HG10.390-LS	46683301930	PTFE Spacer	1pc
HG10.349-LS	46683301860	Connection Cover for cable PTFE	1pc	HG10.344-LS	46683301170	Connector	1pc
HG10.393-LS	46683301330	No Longer Available	1pc	HG10.336-LS	46683301090	PTFE Spacer 30x4	1pc
HG14.840-LS	46683301841	Nozzle Cover	1pc	HG10.340-LS	46683301120	PTFE Spacer 24x3	1pc
HG10.333-LS	46683301080	PTFE Spacer 27x5.5	1pc	HG13.414-LS	36143310522	Nozzle Adapter	1pc
HG10.342-LS	46683301130	PTFE spacer 24x4	1pc	HG13.417-LS	46143312170	Insulating Ring	1pc
HG13.428-LS	46773300710	Ceramic spacer 24x4	1pc	HG13.403-LS	46713300321	Vespel Nut - Space Gear	1pc
HG13.404-LS	46713330960	Washer for cone	1pc	HG13.429-LS	46683301930P	Special Protection - Peek	1pc
HG13.409-LS	46713330940	Torch Inner Tip	1pc	HG13.416-LS	46143312120	Insulating PPS 40x5	1pc
HG13.405-LS	P0492-702-00001	Insulating Ring	1pc	HG13.413-LS	46143312100	Insulating PPS 38x5.5	1pc
HG13.412-LS	46143312130	Insulating PPS 40x4	1pc	HG13.410-LS	46713330930	Inner Sensor Cone	1pc
HG13.406-LS	46713330920	Insulating Ring	1pc	HG13.402-LS	46683301851	Connector cover PTFE	1pc
HG10.434-LS	36143304401	Coupler	1pc	HG13.407-LS	46713330951	Connector Cap	1pc
HG13.401-LS	46683301910	Connector cover for cable PTFE	1pc				
HG13.408-LS	46713331111	Connector	1pc				

PolyTetraFluoroEthylene is a fluorocarbon-based polymer and is commonly abbreviated PTFE. The Teflon® brand of PTFE is manufactured only by DuPont® and is not sold by THERMACUT®. THERMACUT® purchases other brands of PTFE from various high quality manufacturers.

Last update of this page: 21/04/2022. See Revision history for details.

FOR US MARKET ONLY
THERMACUT® REPLACEMENT PARTS SUITABLE FOR
MAZAK®
LENSES SUITABLE FOR MAZAK®



Part No.	Ref. No.	Description	Std. Pkg.	Part No.	Ref. No.	Description	Std. Pkg.
HG10.167/H	HG10.167/H	5.00" ZnSe Meniscus lens High pressure lens (29bar), 38.1mm Effective focal length: 127.0mm Edge thickness: 7.4mm AR/AR for 10.6µm (absorption <0.20%)	1pc	HG15.016/H	HG15.016/H	7.50" ZnSe Plano-convex lens High pressure lens (29bar), 38.1mm Effective focal length: 190.5mm Edge thickness: 7.6mm AR/AR for 10.6µm (absorption <0.20%)	1pc
HG15.015/H	HG15.015/H	5.00" ZnSe Plano-convex lens High pressure lens (28bar), 38.1mm Effective focal length: 127.0mm Edge thickness: 7.6mm AR/AR for 10.6µm (absorption <0.20%)	1pc	HG10.621/H	HG10.621/H	7.50" ZnSe Meniscus lens High pressure lens (28bar), 50.8mm Effective focal length: 190.5mm Edge thickness: 9.7mm AR/AR for 10.6µm (absorption <0.20%)	1pc
HG15.024/H ^{OD}	HG15.024/H	5.00" ZnSe Plano-convex lens High pressure lens (33bar), 38.1mm Effective focal length: 127.0mm Edge thickness: 7.87mm AR/AR for 10.6µm (absorption <0.20%)	1pc	HG15.028/H	HG15.028/H	7.50" ZnSe Plano-convex lens High pressure lens (19bar), 50.8mm Effective focal length: 190.5mm Edge thickness: 7.87mm AR/AR for 10.6µm (absorption <0.20%)	1pc
HG15.002/H	HG15.002/H	5.00" ZnSe Plano-convex lens High pressure lens (28bar), 50.8mm Effective focal length: 127.0mm Edge thickness: 9.7mm AR/AR for 10.6µm (absorption <0.20%)	1pc	HG15.003/H	HG15.003/H	7.50" ZnSe Plano-convex lens High pressure lens (28bar), 50.8mm Effective focal length: 190.5mm Edge thickness: 9.7mm AR/AR for 10.6µm (absorption <0.20%)	1pc
HG10.168/H	HG10.168/H	7.50" ZnSe Meniscus lens High pressure lens (29bar), 38.1mm Effective focal length: 190.5mm Edge thickness: 7.4mm AR/AR for 10.6µm (absorption <0.20%)	1pc	HG10.167/HU	HG10.167/HU	5.00" ZnSe Men. lens - ULTRA LOW High pressure lens (29bar), 38.1mm Effective focal length: 127.0mm Edge thickness: 7.4mm AR/AR for 10.6µm (absorption <0.13%)	1pc
				HG10.168/HU	HG10.168/HU	7.50" ZnSe Men. lens - ULTRA LOW High pressure lens (29bar), 38.1mm Effective focal length: 190.5mm Edge thickness: 7.4mm AR/AR for 10.6µm (absorption <0.13%)	1pc

FOR US MARKET ONLY
ACCESSORIES SUITABLE FOR MAZAK®

Part No.	Ref. No.	Description	Std. Pkg.
HG10.174	HG10.174	Polish for laser optics, 250ml, 0367432/2243066	1pc
HG10.173	HG10.173	Lens cleaning paper from TIFFEN®, sheet size 70 × 115mm	50pcs

^{OD} ON DEMAND – WE DO NOT KEEP THESE PARTS IN STOCK, COST IS SET ACCORDING TO THE ORDERED QUANTITY, DELIVERY TIME MAY DIFFER FROM STANDARD PRODUCTS.

Last update of this page: 05/01/2024. See Revision history for details.

THERMACUT® REPLACEMENT PARTS SUITABLE FOR MITSUBISHI®

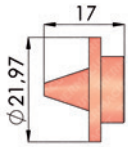

HG12.501-HG12.502

Double copper inserts

Part No.	Ref. No.	Description	Std. Pkg.	Part No.	Ref. No.	Description	Std. Pkg.
HG12.501	W270	Double Nozzle Insert 8-holes	10pcs	HG12.504	W515	Double Nozzle Insert 24-holes	10pcs
HG12.502	OD W387	Double Nozzle Insert 12-holes	10pcs	HG12.505	W269	Double Nozzle	1pc

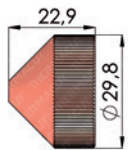

HG12.540-HG12.545

Part No.	Ref. No.	Description	Std. Pkg.	Part No.	Ref. No.	Description	Std. Pkg.
HG12.540	W1626	Nozzle 1.0mm	10pcs	HG12.545	W1629	Nozzle 2.0mm	10pcs
HG12.541	W1627	Nozzle 1.2mm	1pc	HG12.546	W1630	Nozzle 2.5mm	10pcs
HG12.543	W1628	Nozzle 1.5mm	10pcs	HG12.550	W1664	Nozzle 3.0mm	1pc
HG12.544	W1661	Nozzle 1.7mm	10pcs	HG12.551	W1665	Nozzle 3.5mm	10pcs

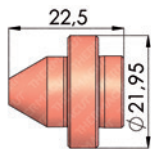

HG12.507-HG12.509

Part No.	Ref. No.	Description	Std. Pkg.	Part No.	Ref. No.	Description	Std. Pkg.
HG12.507	BQ943D157H01	Nozzle 1.5mm	10pcs	HG12.530	HG12.530	Nozzle Nut Short (15mm)	1pc
HG12.508	BQ943D157H02	Nozzle 2.0mm	10pcs				
HG12.509	BQ943D157H03	Nozzle 2.5mm	10pcs				
HG12.520	W777	Nozzle 1.2mm	10pcs				

OD ON DEMAND – WE DO NOT KEEP THESE PARTS IN STOCK, COST IS SET ACCORDING TO THE ORDERED QUANTITY, DELIVERY TIME MAY DIFFER FROM STANDARD PRODUCTS.

Last update of this page: 27/06/2022. See Revision history for details.

THERMACUT®
THE CUTTING COMPANY®

WWW.THERMACUT.COM
TEL.: +420 556 423 440
SALES@THERMACUT.CZ

THERMACUT®, THE CUTTING COMPANY®, FHT-EX®, EX-TRAFIRE®, EX-TRACK®, EX-TRABEAM® AND EX-TRAFLEAME® ARE REGISTERED TRADEMARKS OF THERMACUT, K.S. AND MAY BE REGISTERED IN CZECH REPUBLIC AND/OR OTHER COUNTRIES. ALL OTHER TRADEMARKS ARE PROPERTIES OF THEIR RESPECTIVE OWNERS. THERMACUT® IS IN NO WAY AFFILIATED WITH MITSUBISHI®. MOST THERMACUT® PARTS ARE MADE FOR OR BY AN IBG COMPANY.
VALID FROM MARCH 2024 • PREVIOUS VERSION IS NO LONGER VALID. • © COPYRIGHT 2024 BY THERMACUT® CZECH REPUBLIC. ALL RIGHTS RESERVED.

THERMACUT® REPLACEMENT PARTS SUITABLE FOR MITSUBISHI® LENSES SUITABLE FOR MITSUBISHI®



Part No.	Ref. No.	Description	Std. Pkg.	Part No.	Ref. No.	Description	Std. Pkg.
HG15.015/H	W500	5.00" ZnSe Plano-convex lens High pressure lens (29bar), 38.1mm Effective focal length: 127.0mm Edge thickness: 7.6mm AR/AR for 10.6µm (absorption <0.20%)	1pc	HG15.002/H	W813	5.00" ZnSe Plano-convex lens High pressure lens (28bar), 50.8mm Effective focal length: 127.0mm Edge thickness: 9.7mm AR/AR for 10.6µm (absorption <0.20%)	1pc
HG15.024/H OD	W505	5.00" ZnSe Plano-convex lens High pressure lens (33bar), 38.1mm Effective focal length: 127.0mm Edge thickness: 7.87mm AR/AR for 10.6µm (absorption <0.20%)	1pc	HG15.002/HU	W813	5.00" ZnSe Plan.-con. - ULTRA LOW High pressure lens (19bar), 50.8mm Effective focal length: 127.0mm Edge thickness: 9.7mm AR/AR for 10.6µm (absorption <0.13%)	1pc
HG15.028/H	W510	5.00" ZnSe Plano-convex lens High pressure lens (19bar), 50.8mm Effective focal length: 190.5mm Edge thickness: 7.87mm AR/AR for 10.6µm (absorption <0.20%)	1pc	HG15.028/HU	W510UL	7.50" ZnSe Plan.-con. - ULTRA LOW High pressure lens (19bar), 50.8mm Effective focal length: 190.5mm Edge thickness: 7.87mm AR/AR for 10.6µm (absorption <0.13%)	1pc
HG15.016/H	HG15.016/H	7.50" ZnSe Plano-convex lens High pressure lens (29bar), 38.1mm Effective focal length: 190.5mm Edge thickness: 7.6mm AR/AR for 10.6µm (absorption <0.20%)	1pc	HG15.003/HU OD	W015UL	7.50" ZnSe Plan.-con. - ULTRA LOW High pressure lens (28bar), 50.8mm Effective focal length: 190.5mm Edge thickness: 9.7mm AR/AR for 10.6µm (absorption <0.13%)	1pc
HG15.003/H	W015	7.50" ZnSe Plano-convex lens High pressure lens (29bar), 50.8mm Effective focal length: 190.5mm Edge thickness: 9.7mm AR/AR for 10.6µm (absorption <0.20%)	1pc				
HG15.015/HU OD	W500	5.00" ZnSe Plan.-con. - ULTRA LOW High pressure lens (29bar), 38.1mm Effective focal length: 127.0mm Edge thickness: 7.6mm AR/AR for 10.6µm (absorption <0.13%)	1pc				

ACCESSORIES SUITABLE FOR MITSUBISHI®

Part No.	Ref. No.	Description	Std. Pkg.
HG10.174	HG10.174	Polish for laser optics, 250ml, 0367432/2243066	1pc
HG10.173	HG10.173	Lens cleaning paper from TIFFEN®, sheet size 70 x 115mm	50pcs
HG15.136 OD	HG15.136	Latex gloves	100pcs

OD ON DEMAND – WE DO NOT KEEP THESE PARTS IN STOCK, COST IS SET ACCORDING TO THE ORDERED QUANTITY, DELIVERY TIME MAY DIFFER FROM STANDARD PRODUCTS.

Last update of this page: 05/01/2024. See Revision history for details.

THERMACUT®
THE CUTTING COMPANY®

WWW.THERMACUT.COM
TEL.: +420 556 423 440
SALES@THERMACUT.CZ

THERMACUT®, THE CUTTING COMPANY®, FHT-EX®, EX-TRAFIRE®, EX-TRACK®, EX-TRABEAM® AND EX-TRAFLEAME® ARE REGISTERED TRADEMARKS OF THERMACUT, K.S. AND MAY BE REGISTERED IN CZECH REPUBLIC AND/OR OTHER COUNTRIES. ALL OTHER TRADEMARKS ARE PROPERTIES OF THEIR RESPECTIVE OWNERS. THERMACUT® IS IN NO WAY AFFILIATED WITH MITSUBISHI® AND THE TIFFEN COMPANY. MOST THERMACUT® PARTS ARE MADE FOR OR BY AN IBG COMPANY.
VALID FROM MARCH 2024 • PREVIOUS VERSION IS NO LONGER VALID. • © COPYRIGHT 2024 BY THERMACUT® CZECH REPUBLIC. ALL RIGHTS RESERVED.

THERMACUT® REPLACEMENT PARTS SUITABLE FOR Precitec®

Precitec® (Weidmüller®), ADIGE® SALA, ESAB®, GHT™, HACO®, BALLIU™,
FINN-POWER®, CR electronic®, MESSER-GRIESHEIM®



HG11.100

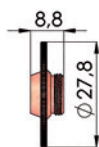

HG11.139

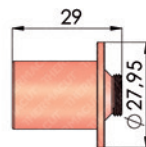

HG11.160

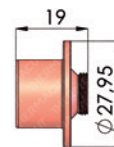

HG11.161

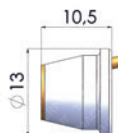

HG10.230

Part No.	Ref. No.	Description	Std. Pkg.	Part No.	Ref. No.	Description	Std. Pkg.
HG11.100	P0571-1051-00001	Ceramic Nozzle Holder	1pc			Length 19mm - Flatbed	
HG11.139	HG11.139	Nozzle Adapter for TRUMPF® Flatbed	1pc	HG11.162	004.4312.041	Nozzle Adapter for TRUMPF® Length 30mm - TLC®	1pc
HG11.160	004.4312.040	Nozzle Adapter for TRUMPF® Length 29mm - Flatbed	1pc	HG11.163 OD	004.4312.034	Nozzle Adapter for TRUMPF® Length 20mm - TLC®	1pc
HG11.161	004.4312.032	Nozzle Adapter for TRUMPF®	1pc	HG10.230	P0491-130-00001	Ceramic Holder KT M1.5" KS	1pc



HG11.120-HG11.125

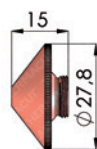

HG11.126-HG11.138

Standard copper nozzles / Double copper nozzles

Part No.	Ref. No.	Description	Std. Pkg.	Part No.	Ref. No.	Description	Std. Pkg.
HG11.120	P0571-291-00010	Nozzle 1.0mm	10pcs	HG11.128	HG11.128	Nozzle 3.5mm	10pcs
HG11.121	P0571-292-00012	Nozzle 1.2mm	10pcs	HG11.127	P0591-578-00040	Nozzle 4.0mm	10pcs
HG11.122	P0571-293-00015	Nozzle 1.5mm	10pcs	HG11.126	P0591-579-00050	Nozzle 5.0mm	10pcs
HG11.123	P0571-294-00018	Nozzle 1.8mm	10pcs	HG11.300	P0591-002-00010	Double Nozzle 1.0mm	10pcs
HG11.124 OD	P0571-295-00020	Nozzle 2.0mm	10pcs	HG11.301	P0591-002-00012	Double Nozzle 1.2mm	10pcs
HG11.125 OD	P0571-297-00025	Nozzle 2.5mm	10pcs	HG11.302	P0591-002-00015	Double Nozzle 1.5mm	10pcs
HG11.129	P0591-673-00008	Nozzle 0.8mm	10pcs	HG11.303	P0591-002-00018	Double Nozzle 1.8mm	10pcs
HG11.130	P0591-571-00010	Nozzle 1.0mm	10pcs	HG11.304	P0591-002-00020	Double Nozzle 2.0mm	10pcs
HG11.131	P0591-572-00012	Nozzle 1.2mm	10pcs	HG11.305	P0591-002-00023	Double Nozzle 2.3mm	10pcs
HG11.132	P0591-573-00015	Nozzle 1.5mm	10pcs	HG11.306	P0591-002-00025	Double Nozzle 2.5mm	10pcs
HG11.133	P0591-574-00018	Nozzle 1.8mm	10pcs	HG11.307	P0591-002-00030	Double Nozzle 3.0mm	10pcs
HG11.134	P0591-575-00020	Nozzle 2.0mm	10pcs	HG11.308	P0591-002-00035	Double Nozzle 3.5mm	10pcs
HG11.135	HG11.135	Nozzle 2.3mm	10pcs	HG11.150	P0571-281-00010	Nozzle 1.0mm	10pcs
HG11.136	P0591-576-00025	Nozzle 2.5mm	10pcs				
HG11.137	HG11.137	Nozzle 2.7mm	10pcs				
HG11.138	P0591-577-00030	Nozzle 3.0mm	10pcs				

OD ON DEMAND – WE DO NOT KEEP THESE PARTS IN STOCK, COST IS SET ACCORDING TO THE ORDERED QUANTITY, DELIVERY TIME MAY DIFFER FROM STANDARD PRODUCTS.

Last update of this page: 29/01/2024. See Revision history for details.

THERMACUT®
THE CUTTING COMPANY®

WWW.THERMACUT.COM
TEL.: +420 556 423 440
SALES@THERMACUT.CZ

THERMACUT®, THE CUTTING COMPANY®, FHT-EX®, EX-TRAFIRE®, EX-TRACK®, EX-TRABEAM® AND EX-TRAFLEAME® ARE REGISTERED TRADEMARKS OF THERMACUT, K.S. AND MAY BE REGISTERED IN CZECH REPUBLIC AND/OR OTHER COUNTRIES. ALL OTHER TRADEMARKS ARE PROPERTIES OF THEIR RESPECTIVE OWNERS. THERMACUT® IS IN NO WAY AFFILIATED WITH Precitec®, Weidmüller®, ADIGE® SALA, ESAB®, HACO®, FINN-POWER®, CR electronic®, MESSER-GRIESHEIM®, TRUMPF®, TLC®. MOST THERMACUT® PARTS ARE MADE FOR OR BY AN IBG COMPANY.

VALID FROM MARCH 2024 • PREVIOUS VERSION IS NO LONGER VALID. • © COPYRIGHT 2024 BY THERMACUT® CZECH REPUBLIC. ALL RIGHTS RESERVED.

THERMACUT® REPLACEMENT PARTS SUITABLE FOR Precitec®

Precitec® (Weidmüller®), ADIGE® SALA, ESAB®, GHT™, HACO®, BALLIU™,
FINN-POWER®, CR electronic®, MESSER-GRIESHEIM®

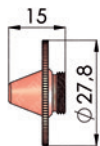

HG11.101-HG11.106, HG11.108

Standard copper nozzles

Part No.	Ref. No.	Description	Std. Pkg.	Part No.	Ref. No.	Description	Std. Pkg.
HG11.101	P0591-569-00008	Nozzle 0.8mm	10pcs	HG11.105	P0591-564-00018	Nozzle 1.8mm	10pcs
HG11.102	P0591-561-00010	Nozzle 1.0mm	10pcs	HG11.106	P0591-565-00020	Nozzle 2.0mm	10pcs
HG11.103	P0591-562-00012	Nozzle 1.2mm	10pcs	HG11.108	P0591-566-00025	Nozzle 2.5mm	10pcs
HG11.104	P0591-563-00015	Nozzle 1.5mm	10pcs				



HG11.020-HG11.024

Part No.	Ref. No.	Description	Std. Pkg.	Part No.	Ref. No.	Description	Std. Pkg.
HG11.020	P0578-0411-00010	Nozzle 1.0mm	10pcs	HG11.024	P0578-0415-00020	Nozzle 2.0mm	10pcs
HG11.021	P0578-0412-00012	Nozzle 1.2mm	10pcs				
HG11.022	P0578-0413-00015	Nozzle 1.5mm	10pcs				
HG11.023	P0578-0414-00018	Nozzle 1.8mm	10pcs				

Long copper nozzles

Part No.	Ref. No.	Description	Std. Pkg.	Part No.	Ref. No.	Description	Std. Pkg.
HG11.141	P0573-563-00012	Long Nozzle 1.2mm	10pcs	HG11.146	P0573-566-00025	Long Nozzle 2.5mm	10pcs
HG11.142	P0573-563-00015	Long Nozzle 1.5mm	10pcs	HG11.147	HG11.147	Long Nozzle 3.0mm	10pcs
HG11.144	P0573-564-00020	Long Nozzle 2.0mm	10pcs				
HG11.145	P0573-565-00023	Long Nozzle 2.3mm	10pcs				

Last update of this page: 29/03/2024. See Revision history for details.

THERMACUT®
THE CUTTING COMPANY®

WWW.THERMACUT.COM
TEL.: +420 556 423 440
SALES@THERMACUT.CZ

THERMACUT®, THE CUTTING COMPANY®, FHT-EX®, EX-TRAFIRE®, EX-TRACK®, EX-TRABEAM® AND EX-TRAFLEAME® ARE REGISTERED TRADEMARKS OF THERMACUT, K.S. AND MAY BE REGISTERED IN CZECH REPUBLIC AND/OR OTHER COUNTRIES. ALL OTHER TRADEMARKS ARE PROPERTIES OF THEIR RESPECTIVE OWNERS. THERMACUT® IS IN NO WAY AFFILIATED WITH Precitec®, Weidmüller®, ADIGE® SALA, ESAB®, HACO®, FINN-POWER®, CR electronic®, MESSER-GRIESHEIM®. MOST THERMACUT® PARTS ARE MADE FOR OR BY AN IBG COMPANY. VALID FROM MARCH 2024 • PREVIOUS VERSION IS NO LONGER VALID. © COPYRIGHT 2024 BY THERMACUT® CZECH REPUBLIC. ALL RIGHTS RESERVED.

THERMACUT® REPLACEMENT PARTS SUITABLE FOR Precitec®

Precitec® (Weidmüller®), ADIGE® SALA, ESAB®, GHT™, HACO®, BALLIU™,
FINN-POWER®, CR electronic®, MESSER-GRIESHEIM®



HG11.129/C–HG11.134/C

Standard copper nozzles with chromium plating

Part No.	Ref. No.	Description	Std. Pkg.	Part No.	Ref. No.	Description	Std. Pkg.
HG11.129/C OD	P0591-673-0008CP	Nozzle 0.8mm HCP	10pcs	HG11.135/C OD	HG11.135CP	Nozzle 2.3mm HCP	10pcs
HG11.130/C	P0591-571-00010CP	Nozzle 1.0mm HCP	10pcs	HG11.136/C	P0591-576-00025CP	Nozzle 2.5mm HCP	10pcs
HG11.131/C	P0591-572-00012CP	Nozzle 1.2mm HCP	10pcs	HG11.137/C	HG11.137CP	Nozzle 2.7mm HCP	10pcs
HG11.132/C	P0591-573-00015CP	Nozzle 1.5mm HCP	10pcs	HG11.138/C	P0591-577-00030CP	Nozzle 3.0mm HCP	10pcs
HG11.133/C OD	P0591-574-00018CP	Nozzle 1.8mm HCP	10pcs	HG11.128/C	HG11.128CP	Nozzle 3.5mm HCP	10pcs
HG11.134/C	P0591-575-00020CP	Nozzle 2.0mm HCP	10pcs				



HG11.300/C–HG11.304/C

Double copper nozzles with chromium plating

Part No.	Ref. No.	Description	Std. Pkg.	Part No.	Ref. No.	Description	Std. Pkg.
HG11.300/C	P0591-002-00010CP	Double Nozzle 1.0mm HCP	10pcs	HG11.306/C	P0591-002-00025CP	Double Nozzle 2.5mm HCP	10pcs
HG11.301/C	P0591-002-00012CP	Double Nozzle 1.2mm HCP	10pcs	HG11.307/C	P0591-002-00030CP	Double Nozzle 3.0mm HCP	10pcs
HG11.302/C	P0591-002-00015CP	Double Nozzle 1.5mm HCP	10pcs	HG11.308/C OD	P0591-002-00035CP	Double Nozzle 3.5mm HCP	10pcs
HG11.303/C	P0591-002-00018CP	Double Nozzle 1.8mm HCP	10pcs				
HG11.304/C	P0591-002-00020CP	Double Nozzle 2.0mm HCP	10pcs				
HG11.305/C	P0591-002-00023CP	Double Nozzle 2.3mm HCP	10pcs				

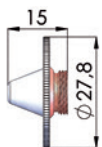

HG11.103/C–HG11.104/C

Standard copper nozzles with chromium plating

Part No.	Ref. No.	Description	Std. Pkg.	Part No.	Ref. No.	Description	Std. Pkg.
HG11.103/C OD	P0591-562-00012CP	Nozzle 1.2mm HCP	10pcs	HG11.110/C	P0591-568-00030CP	Nozzle 3.0mm HCP	10pcs
HG11.104/C OD	P0591-563-00015CP	Nozzle 1.5mm HCP	10pcs				
HG11.106/C	P0591-565-00020CP	Nozzle 2.0mm HCP	10pcs				
HG11.109/C	HG11.109CP	Nozzle 2.7mm HCP	10pcs				

OD ON DEMAND – WE DO NOT KEEP THESE PARTS IN STOCK, COST IS SET ACCORDING TO THE ORDERED QUANTITY, DELIVERY TIME MAY DIFFER FROM STANDARD PRODUCTS.

Last update of this page: 27/06/2022. See Revision history for details.

THERMACUT®
THE CUTTING COMPANY®

WWW.THERMACUT.COM
TEL.: +420 556 423 440
SALES@THERMACUT.CZ

THERMACUT®, THE CUTTING COMPANY®, FHT-EX®, EX-TRAFIRE®, EX-TRACK®, EX-TRABEAM® AND EX-TRAFLEAME® ARE REGISTERED TRADEMARKS OF THERMACUT, K.S. AND MAY BE REGISTERED IN CZECH REPUBLIC AND/OR OTHER COUNTRIES. ALL OTHER TRADEMARKS ARE PROPERTIES OF THEIR RESPECTIVE OWNERS. THERMACUT® IS IN NO WAY AFFILIATED WITH Precitec®, Weidmüller®, ADIGE® SALA, ESAB®, HACO®, FINN-POWER®, CR electronic®, MESSER-GRIESHEIM®. MOST THERMACUT® PARTS ARE MADE FOR OR BY AN IBG COMPANY. VALID FROM MARCH 2024 • PREVIOUS VERSION IS NO LONGER VALID. • © COPYRIGHT 2024 BY THERMACUT® CZECH REPUBLIC. ALL RIGHTS RESERVED.

THERMACUT® REPLACEMENT PARTS SUITABLE FOR

Precitec®

Precitec® (Weidmüller®) 5" KN/MG

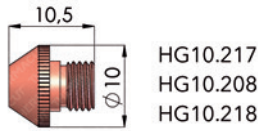

Standard copper nozzels

Part No.	Ref. No.	Description	Std. Pkg.	Part No.	Ref. No.	Description	Std. Pkg.
HG10.217	P0494-853-00010	Nozzle 1.0mm	10pcs	HG10.226	HG10.226	Slop-Cutting Nozzle 1.2mm	10pcs
HG10.208	P0494-854-00012	Nozzle 1.2mm	10pcs	HG10.220 OD	HG10.220	Slop-Cutting Nozzle 1.4mm	10pcs
HG10.218	P0494-855-00015	Nozzle 1.5mm	10pcs	HG10.221 OD	HG10.221	Slop-Cutting Nozzle 1.7mm	10pcs
HG10.225	HG10.225	Slop-Cutting Nozzle 1.0mm	10pcs				

SUITABLE FOR Precitec® DE YR30

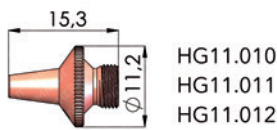

Part No.	Ref. No.	Description	Std. Pkg.	Part No.	Ref. No.	Description	Std. Pkg.
HG11.010	P0787-481-00010	Nozzle 1.0mm	10pcs	HG11.012 OD	P0787-483-00015	Nozzle 1.5mm	10pcs
HG11.011	P0787-482-00012	Nozzle 1.2mm	10pcs	HG11.014 OD	P0787-1001-00020	Nozzle 2.0mm	10pcs

SUITABLE FOR Precitec® KTX SERIES

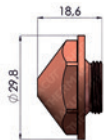

Part No.	Ref. No.	Description	Std. Pkg.	Part No.	Ref. No.	Description	Std. Pkg.
HG11.110	P0595-92036	Ceramic Holder KTX	1pc	HG11.323	P0595-92881	Double Nozzle 1.4mm	10pcs
HG11.310	P0595-94263	Nozzle 1.0mm	10pcs	HG11.324	P0595-92883	Double Nozzle 1.5mm	10pcs
HG11.311	P0595-92688	Nozzle 1.2mm	10pcs	HG11.325	P0595-92886	Double Nozzle 1.8mm	10pcs
HG11.312	P0595-92733	Nozzle 1.5mm	10pcs	HG11.326	P0595-92901	Double Nozzle 2.0mm	10pcs
HG11.313	P0595-92734	Nozzle 1.7mm	10pcs	HG11.327	P0595-92904	Double Nozzle 2.3mm	10pcs
HG11.314	P0595-92735	Nozzle 2.0mm	10pcs	HG11.328	P0595-92906	Double Nozzle 2.5mm	10pcs
HG11.315	P0595-92736	Nozzle 2.5mm	10pcs	HG11.329	P0595-92909	Double Nozzle 3.0mm	10pcs
HG11.316	P0595-92737	Nozzle 3.0mm	10pcs	HG11.330	P0595-92911	Double Nozzle 3.5mm	10pcs
HG11.317	P0595-92738	Nozzle 3.5mm	10pcs	HG11.331	P0595-92913	Double Nozzle 4.0mm	10pcs
HG11.318	P0595-92739	Nozzle 4.0mm	10pcs	HG11.332	P0595-92915	Double Nozzle 4.5mm	10pcs
HG11.319	P0595-92741	Nozzle 5.0mm	10pcs	HG11.333	P0595-92917	Double Nozzle 5.0mm	10pcs
HG11.320	P0595-92868	Double Nozzle 0.8mm	10pcs				
HG11.321	P0595-92871	Double Nozzle 1.0mm	10pcs				
HG11.322	P0595-92879	Double Nozzle 1.2mm	10pcs				

OD ON DEMAND – WE DO NOT KEEP THESE PARTS IN STOCK, COST IS SET ACCORDING TO THE ORDERED QUANTITY, DELIVERY TIME MAY DIFFER FROM STANDARD PRODUCTS.

Last update of this page: 05/01/2024. See Revision history for details.

THERMACUT®
THE CUTTING COMPANY®

WWW.THERMACUT.COM
TEL.: +420 556 423 440
SALES@THERMACUT.CZ

THERMACUT®, THE CUTTING COMPANY®, FHT-EX®, EX-TRAFIRE®, EX-TRACK®, EX-TRABEAM® AND EX-TRAFLEAME® ARE REGISTERED TRADEMARKS OF THERMACUT, K.S. AND MAY BE REGISTERED IN CZECH REPUBLIC AND/OR OTHER COUNTRIES. ALL OTHER TRADEMARKS ARE PROPERTIES OF THEIR RESPECTIVE OWNERS. THERMACUT® IS IN NO WAY AFFILIATED WITH Precitec®, Weidmüller®. MOST THERMACUT® PARTS ARE MADE FOR OR BY AN IBG COMPANY.
VALID FROM MARCH 2024 • PREVIOUS VERSION IS NO LONGER VALID. • © COPYRIGHT 2024 BY THERMACUT® CZECH REPUBLIC. ALL RIGHTS RESERVED.

THERMACUT® REPLACEMENT PARTS SUITABLE FOR BLM® ADIGE™ SERIES

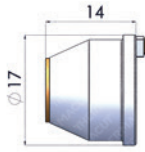

HG11.250

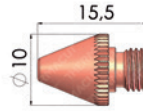

HG10.231

Part No.	Ref. No.	Description	Std. Pkg.	Part No.	Ref. No.	Description	Std. Pkg.
HG11.250	P0494-752-00001	Ceramic Holder KT M1.5" KN	1pc	HG10.234	6930250034	Nozzle TCL 1.8mm	10pcs
HG10.231	6930250031	Nozzle TCL 1.0mm	10pcs	HG10.235	6930250035	Nozzle TCL 2.0mm	10pcs
HG10.232	6930250032	Nozzle TCL 1.2mm	10pcs	HG10.236	6930250036	Nozzle TCL 2.5mm	10pcs
HG10.233	6930250033	Nozzle TCL 1.5mm	10pcs				



PRODUCT BROCHURE WITH DETAILS AT
WWW.THERMACUT.COM

▶ VIDEO AVAILABLE AT YOUTUBE CHANNEL ▶

LENSES SUITABLE FOR Precitec®

Part No.	Ref. No.	Description	Std. Pkg.	Part No.	Ref. No.	Description	Std. Pkg.
HG10.731/H	HG10.731/H	5.00" ZnSe Meniscus lens High pressure lens (20bar), 38.1mm Effective focal length: 127.0mm Edge thickness: 6.0mm AR/AR for 10.6µm (absorption <0.20%)	1pc	HG10.168/H	HG10.168/H	7.50" ZnSe Meniscus lens High pressure lens (29bar), 38.1mm Effective focal length: 190.5mm Edge thickness: 7.4mm AR/AR for 10.6µm (absorption <0.20%)	1pc
HG10.732/H	HG10.732/H	7.50" ZnSe Meniscus lens High pressure lens (20bar), 38.1mm Effective focal length: 190.5mm Edge thickness: 6.0mm AR/AR for 10.6µm (absorption <0.20%)	1pc	HG10.733/H	HG10.733/H	5.00" ZnSe Meniscus lens High pressure lens (42bar), 38.1mm Effective focal length: 127.0mm Edge thickness: 9.0mm AR/AR for 10.6µm (absorption <0.20%)	1pc
HG10.166/H	HG10.166/H	3.75" ZnSe Meniscus lens High pressure lens (29bar), 38.1mm Effective focal length: 95.3mm Edge thickness: 7.4mm AR/AR for 10.6µm (absorption <0.20%)	1pc	HG10.734/H	HG10.734/H	7.50" ZnSe Meniscus lens High pressure lens (42bar), 38.1mm Effective focal length: 190.5mm Edge thickness: 9.0mm AR/AR for 10.6µm (absorption <0.20%)	1pc
HG10.167/H	HG10.167/H	5.00" ZnSe Meniscus lens High pressure lens (29bar), 38.1mm Effective focal length: 127.0mm Edge thickness: 7.4mm AR/AR for 10.6µm (absorption <0.20%)	1pc	HG10.621/H	HG10.621/H	7.50" ZnSe Meniscus lens High pressure lens (28bar), 50.8mm Effective focal length: 190.5mm Edge thickness: 9.7mm AR/AR for 10.6µm (absorption <0.20%)	1pc

OD ON DEMAND – WE DO NOT KEEP THESE PARTS IN STOCK, COST IS SET ACCORDING TO THE ORDERED QUANTITY, DELIVERY TIME MAY DIFFER FROM STANDARD PRODUCTS.

Last update of this page: 29/01/2024. See Revision history for details.

THERMACUT®
THE CUTTING COMPANY®

WWW.THERMACUT.COM
TEL.: +420 556 423 440
SALES@THERMACUT.CZ

THERMACUT®, THE CUTTING COMPANY®, FHT-EX®, EX-TRAFIRE®, EX-TRACK®, EX-TRABEAM® AND EX-TRAFLEAME® ARE REGISTERED TRADEMARKS OF THERMACUT, K.S. AND MAY BE REGISTERED IN CZECH REPUBLIC AND/OR OTHER COUNTRIES. ALL OTHER TRADEMARKS ARE PROPERTIES OF THEIR RESPECTIVE OWNERS. THERMACUT® IS IN NO WAY AFFILIATED WITH Precitec®. MOST THERMACUT® PARTS ARE MADE FOR OR BY AN IBG COMPANY.

VALID FROM MARCH 2024 • PREVIOUS VERSION IS NO LONGER VALID. • © COPYRIGHT 2024 BY THERMACUT® CZECH REPUBLIC. ALL RIGHTS RESERVED.

THERMACUT® REPLACEMENT PARTS SUITABLE FOR Precitec® LENSES SUITABLE FOR Precitec®



Part No.	Ref. No.	Description	Std. Pkg.	Part No.	Ref. No.	Description	Std. Pkg.
HG15.002/H	HG15.002/H	5.00" ZnSe Plano-convex lens High pressure lens (28bar), 50.8mm Effective focal length: 127.0mm Edge thickness: 9.7mm AR/AR for 10.6µm (absorption <0.20%)	1pc	HG15.003/HU OD	HG15.003/HU	7.50" ZnSe Plan.-con. - ULTRA LOW High pressure lens (28bar), 50.8mm Effective focal length: 190.5mm Edge thickness: 9.7mm AR/AR for 10.6µm (absorption <0.13%)	1pc
HG15.003/H	HG15.003/H	7.50" ZnSe Plano-convex lens High pressure lens (28bar), 50.8mm Effective focal length: 190.5mm Edge thickness: 9.7mm AR/AR for 10.6µm (absorption <0.20%)	1pc	HG10.733/HU	HG10.733/HU	5.00" ZnSe Men. lens - ULTRA LOW High pressure lens (42bar), 38.1mm Effective focal length: 127.0mm Edge thickness: 9.0mm AR/AR for 10.6µm (absorption <0.13%)	1pc
HG10.167/HU	HG10.167/HU	5.00" ZnSe Men. lens - ULTRA LOW High pressure lens (29bar), 38.1mm Effective focal length: 127.0mm Edge thickness: 7.4mm AR/AR for 10.6µm (absorption <0.13%)	1pc	HG10.734/HU	HG10.734/HU	7.50" ZnSe Men. lens - ULTRA LOW High pressure lens (42bar), 38.1mm Effective focal length: 190.5mm Edge thickness: 9.0mm AR/AR for 10.6µm (absorption <0.13%)	1pc
HG10.168/HU	HG10.168/HU	7.50" ZnSe Men. lens - ULTRA LOW High pressure lens (29bar), 38.1mm Effective focal length: 190.5mm Edge thickness: 7.4mm AR/AR for 10.6µm (absorption <0.13%)	1pc	HG15.002/HU	HG15.002/HU	5.00" ZnSe Plan.-con. - ULTRA LOW High pressure lens (28bar), 50.8mm Effective focal length: 127.0mm Edge thickness: 9.7mm AR/AR for 10.6µm (absorption <0.13%)	1pc

PROTECTION WINDOWS SUITABLE FOR Precitec®



Part No.	Ref. No.	Description	Std. Pkg.
HG17.511 OD	HG17.511	Protection Window D50.00mm × ET = 2.0mm	1pc
HG17.514	HG17.514	Protection Window D25.40mm × ET = 4.0mm	1pc
HG17.524	P0595-58601	Protection Window D37.00mm × ET = 7.0mm	1pc
HG17.525	HG17.525	Protection Window D21.50mm × ET = 2.0mm	1pc
HG17.526	766719	Protection Window D30.00mm × ET = 5.0mm suitable for TRUMPF®	1pc
HG17.527	HG17.527	Protection Window D30.00mm × ET = 1.50mm YW30	1pc
HG17.512	P0589-360-00001	Protection Window D22.35mm × ET = 4.0mm	1pc

ACCESSORIES SUITABLE FOR Precitec®

Part No.	Ref. No.	Description	Std. Pkg.
HG10.174	HG10.174	Polish for laser optics, 250ml, 0367432/2243066	1pc
HG10.173	HG10.173	Lens cleaning paper from TIFFEN®, sheet size 70 × 115mm	50pcs

OD ON DEMAND – WE DO NOT KEEP THESE PARTS IN STOCK, COST IS SET ACCORDING TO THE ORDERED QUANTITY, DELIVERY TIME MAY DIFFER FROM STANDARD PRODUCTS.

Last update of this page: 29/03/2024. See Revision history for details.

THERMACUT®
THE CUTTING COMPANY®

WWW.THERMACUT.COM
TEL.: +420 556 423 440
SALES@THERMACUT.CZ

THERMACUT®, THE CUTTING COMPANY®, FHT-EX®, EX-TRAFIRE®, EX-TRACK®, EX-TRABEAM® AND EX-TRAFLEAME® ARE REGISTERED TRADEMARKS OF THERMACUT, K.S. AND MAY BE REGISTERED IN CZECH REPUBLIC AND/OR OTHER COUNTRIES. ALL OTHER TRADEMARKS ARE PROPERTIES OF THEIR RESPECTIVE OWNERS. THERMACUT® IS IN NO WAY AFFILIATED WITH Precitec®, TRUMPF®, THE TIFFEN COMPANY AND BLM®. MOST THERMACUT® PARTS ARE MADE FOR OR BY AN IBG COMPANY.
VALID FROM MARCH 2024 • PREVIOUS VERSION IS NO LONGER VALID. • © COPYRIGHT 2024 BY THERMACUT® CZECH REPUBLIC. ALL RIGHTS RESERVED.

THERMACUT® REPLACEMENT PARTS SUITABLE FOR PRIMA POWER®

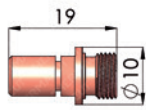

HG10.370

Standard copper nozzles

Part No.	Ref. No.	Description	Std. Pkg.	Part No.	Ref. No.	Description	Std. Pkg.
HG10.370	485.73.114E	Nozzle 2.0mm (485.73.322)	10pcs	HG10.451	HG10.451	Nozzle 2.5mm	10pcs
HG10.371	485.73.114F	Nozzle 2.5mm (485.73.323)	10pcs				

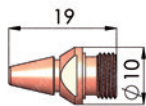

HG10.367
HG10.369

Part No.	Ref. No.	Description	Std. Pkg.	Part No.	Ref. No.	Description	Std. Pkg.
HG10.367	485.73.115A	Nozzle 1.5mm (485.73.331)	10pcs	HG11.367	485.73.451	Nozzle 1.5mm	10pcs
HG10.369	485.73.115C	Nozzle 2.0mm (485.73.333)	10pcs	HG11.369	485.73.452	Nozzle 2.0mm	10pcs
				HG11.373	485.73.453	Nozzle 2.5mm	10pcs

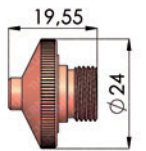

HG10.380-HG10.382

Part No.	Ref. No.	Description	Std. Pkg.	Part No.	Ref. No.	Description	Std. Pkg.
HG10.380	LW6.1E.111	Nozzle 1.5mm	10pcs	HG10.454	LW6.1G.600	Nozzle 1.5mm	10pcs
HG10.381	LW6.1E.112	Nozzle 2.0mm	10pcs	HG10.455	LW6.1G.601	Nozzle 2.0mm	10pcs
HG10.382	LW6.1E.113	Nozzle 2.5mm	10pcs	HG10.456	LW6.1G.602	Nozzle 2.5mm	10pcs
HG10.383 OD	LW6.1E.114	Nozzle 3.0mm	10pcs				

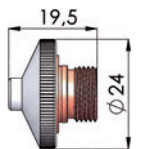

HG10.780

Part No.	Ref. No.	Description	Std. Pkg.	Part No.	Ref. No.	Description	Std. Pkg.
HG10.780 OD	LW6.1G.604	Nozzle 1.5mm CP	10pcs	HG10.782	LW6.1G.605	Nozzle 2.0mm CP	10pcs
HG10.781	HG10.781	Nozzle 1.75mm CP	10pcs	HG10.784	LW6.1G.607	Nozzle 3.0mm CP	10pcs

Part No.	Ref. No.	Description	Std. Pkg.
HG11.369/C	485.73.452CP	Nozzle 2.0mm	10pcs
HG11.373/C	485.73.453CP	Nozzle 2.5mm	10pcs

OD ON DEMAND – WE DO NOT KEEP THESE PARTS IN STOCK, COST IS SET ACCORDING TO THE ORDERED QUANTITY, DELIVERY TIME MAY DIFFER FROM STANDARD PRODUCTS.

Last update of this page: 05/01/2024. See Revision history for details.

THERMACUT®
THE CUTTING COMPANY®

WWW.THERMACUT.COM
TEL.: +420 556 423 440
SALES@THERMACUT.CZ

THERMACUT®, THE CUTTING COMPANY®, FHT-EX®, EX-TRAFIRE®, EX-TRACK®, EX-TRABEAM® AND EX-TRAFLEAME® ARE REGISTERED TRADEMARKS OF THERMACUT, K.S. AND MAY BE REGISTERED IN CZECH REPUBLIC AND/OR OTHER COUNTRIES. ALL OTHER TRADEMARKS ARE PROPERTIES OF THEIR RESPECTIVE OWNERS. THERMACUT® IS IN NO WAY AFFILIATED WITH PRIMA POWER®. MOST THERMACUT® PARTS ARE MADE FOR OR BY AN IBG COMPANY.
VALID FROM MARCH 2024 • PREVIOUS VERSION IS NO LONGER VALID. • © COPYRIGHT 2024 BY THERMACUT® CZECH REPUBLIC. ALL RIGHTS RESERVED.

THERMACUT® REPLACEMENT PARTS SUITABLE FOR PRIMA POWER®

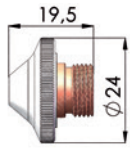

HG11.381/C

Domino copper nozzels with chromium plating

Part No.	Ref. No.	Description	Std. Pkg.
HG11.381/C OD	1059.70000.004	Double Nozzle 1.5mm HCP	10pcs
HG11.382/C	1059.70000.005	Double Nozzle 2.0mm HCP	10pcs



PRODUCT BROCHURE WITH DETAILS AT
WWW.THERMACUT.COM

VIDEO AVAILABLE AT YOUTUBE CHANNEL ▶



LENSES SUITABLE FOR PRIMA POWER®

Part No.	Ref. No.	Description	Std. Pkg.	Part No.	Ref. No.	Description	Std. Pkg.
HG10.733/H	HG10.733/H	5.00" ZnSe Meniscus lens High pressure lens (42bar), 38.1mm Effective focal length: 127.0mm Edge thickness: 9.0mm AR/AR for 10.6µm (absorption <0.20%)	1pc	HG10.733/HU	HG10.733/HU	5.00" ZnSe Men. lens - ULTRA LOW High pressure lens (42bar), 38.1mm Effective focal length: 127.0mm Edge thickness: 9.0mm AR/AR for 10.6µm (absorption <0.13%)	1pc
HG10.734/H	HG10.734/H	7.50" ZnSe Meniscus lens High pressure lens (42bar), 38.1mm Effective focal length: 190.5mm Edge thickness: 9.0mm AR/AR for 10.6µm (absorption <0.20%)	1pc	HG10.734/HU	HG10.734/HU	7.50" ZnSe Men. lens - ULTRA LOW High pressure lens (42bar), 38.1mm Effective focal length: 190.5mm Edge thickness: 9.0mm AR/AR for 10.6µm (absorption <0.13%)	1pc
HG10.621/H	HG10.621/H	7.50" ZnSe Meniscus lens High pressure lens (28bar), 50.8mm Effective focal length: 190.5mm Edge thickness: 9.7mm AR/AR for 10.6µm (absorption <0.20%)	1pc				

ACCESSORIES SUITABLE FOR PRIMA POWER®

Part No.	Ref. No.	Description	Std. Pkg.
HG10.174	HG10.174	Polish for laser optics, 250ml, 0367432/2243066	1pc
HG10.173	HG10.173	Lens cleaning paper from TIFFEN®, sheet size 70 × 115mm	50pcs

OD ON DEMAND – WE DO NOT KEEP THESE PARTS IN STOCK, COST IS SET ACCORDING TO THE ORDERED QUANTITY, DELIVERY TIME MAY DIFFER FROM STANDARD PRODUCTS.

Last update of this page: 05/01/2024. See Revision history for details.

THERMACUT®
THE CUTTING COMPANY®

WWW.THERMACUT.COM
TEL.: +420 556 423 440
SALES@THERMACUT.CZ

THERMACUT®, THE CUTTING COMPANY®, FHT-EX®, EX-TRAFIRE®, EX-TRACK®, EX-TRABEAM® AND EX-TRAFLEAME® ARE REGISTERED TRADEMARKS OF THERMACUT, K.S. AND MAY BE REGISTERED IN CZECH REPUBLIC AND/OR OTHER COUNTRIES. ALL OTHER TRADEMARKS ARE PROPERTIES OF THEIR RESPECTIVE OWNERS. THERMACUT® IS IN NO WAY AFFILIATED WITH PRIMA POWER® AND THE TIFFEN COMPANY. MOST THERMACUT® PARTS ARE MADE FOR OR BY AN IBG COMPANY.
VALID FROM MARCH 2024 • PREVIOUS VERSION IS NO LONGER VALID. • © COPYRIGHT 2024 BY THERMACUT® CZECH REPUBLIC. ALL RIGHTS RESERVED.

THERMACUT® REPLACEMENT PARTS SUITABLE FOR TRUMPF®



HG10.150–HG10.153
HG10.148
HG10.159



HG10.150/C–HG10.152/C
HG10.148/C

Standard copper nozzles / Standard copper nozzles with hard chromium plating

Part No.	Ref. No.	Description	Std. Pkg.	Part No.	Ref. No.	Description	Std. Pkg.
HG10.150	0124561	Nozzle ECE 0.8mm	10pcs	HG10.154	0237501	Nozzle ECE 1.7mm	10pcs
HG10.150/C	0352280	Nozzle ECE 0.8mm HCP	10pcs	HG10.154/C	0352284	Nozzle ECE 1.7mm HCP	10pcs
HG10.151	0124562	Nozzle ECE 1.0mm	10pcs	HG10.155	1253211	Nozzle ECE 2.0mm	10pcs
HG10.151/C	0352281	Nozzle ECE 1.0mm HCP	10pcs	HG10.155/C	1253212	Nozzle ECE 2.0mm HCP	10pcs
HG10.148	0966809	Nozzle ECE 1.2mm	10pcs	HG10.158	0126933	Nozzle ECE 2.3mm	10pcs
HG10.148/C	0352282	Nozzle ECE 1.2mm HCP	10pcs	HG10.158/C	0352285	Nozzle ECE 2.3mm HCP	10pcs
HG10.152	0237497	Nozzle ECE 1.4mm with step	10pcs	HG10.156	HG10.156	Nozzle ECE 2.5mm	10pcs
HG10.152/C	0352283	Nozzle ECE 1.4mm HCP	10pcs	HG10.149	0942742	Nozzle ECE 2.7mm	10pcs
HG10.159	237497-S	Nozzle ECE 1.4mm with Straith Taper	10pcs	HG10.149/C	0352286	Nozzle ECE 2.7mm HCP	10pcs
HG10.153	237500	Nozzle ECE 1.5mm	10pcs	HG10.157	0237504	Nozzle ECE 3.0mm	10pcs

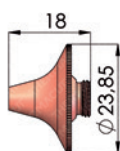

HG10.130–HG10.133

Part No.	Ref. No.	Description	Std. Pkg.	Part No.	Ref. No.	Description	Std. Pkg.
HG10.130	1277773	Nozzle 0.8mm	10pcs	HG10.134	1277779	Nozzle 1.7mm	10pcs
HG10.131	1277771	Nozzle 1.0mm	10pcs	HG10.135 OD	1277780	Nozzle 2.0mm	10pcs
HG10.132	1277774	Nozzle 1.2mm	10pcs	HG10.136	1277781	Nozzle 2.3mm	10pcs
HG10.133	1277776	Nozzle 1.4mm	10pcs	HG10.137 OD	1277782	Nozzle 2.7mm	10pcs

OD ON DEMAND – WE DO NOT KEEP THESE PARTS IN STOCK, COST IS SET ACCORDING TO THE ORDERED QUANTITY, DELIVERY TIME MAY DIFFER FROM STANDARD PRODUCTS.

Last update of this page: 08/02/2022. See Revision history for details.

THERMACUT®
THE CUTTING COMPANY®

WWW.THERMACUT.COM
TEL.: +420 556 423 440
SALES@THERMACUT.CZ

THERMACUT®, THE CUTTING COMPANY®, FHT-EX®, EX-TRAFIRE®, EX-TRACK®, EX-TRABEAM® AND EX-TRAFLEAME® ARE REGISTERED TRADEMARKS OF THERMACUT, K.S. AND MAY BE REGISTERED IN CZECH REPUBLIC AND/OR OTHER COUNTRIES. ALL OTHER TRADEMARKS ARE PROPERTIES OF THEIR RESPECTIVE OWNERS. THERMACUT® IS IN NO WAY AFFILIATED WITH TRUMPF®. MOST THERMACUT® PARTS ARE MADE FOR OR BY AN IBG COMPANY.
VALID FROM MARCH 2024 • PREVIOUS VERSION IS NO LONGER VALID. • © COPYRIGHT 2024 BY THERMACUT® CZECH REPUBLIC. ALL RIGHTS RESERVED.

THERMACUT® REPLACEMENT PARTS SUITABLE FOR TRUMPF®

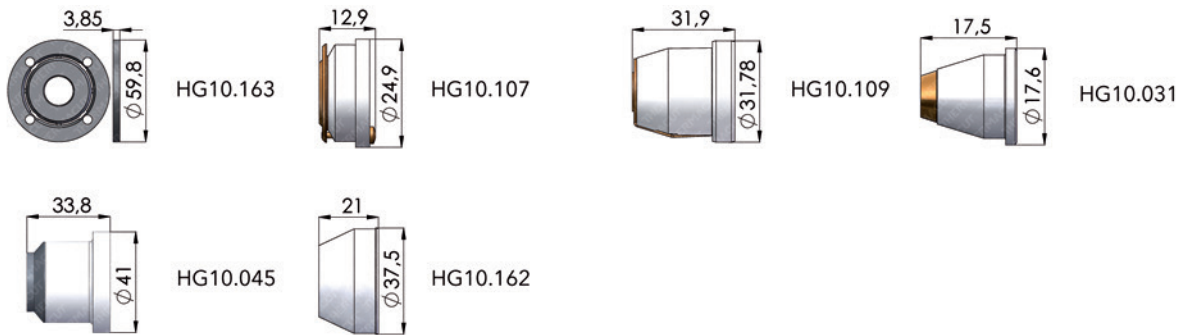

Part No.	Ref. No.	Description	Std. Pkg.
HG10.163	234485	Break Away Bar	1pc
HG10.107	0258809	Ceramic Nozzle Holder (Lasermatic®)	1pc
HG10.109	0260432	Ceramic Nozzle Holder DIAS III	1pc
HG10.031	0936678	Ceramic Nozzle Holder M6	1pc
HG10.045	1906032	Ceramic Nozzle Holder M12	1pc
HG10.080	1755673	Nozzle Holder M12	1pc
HG10.162	256153	PTFE Cover DIAS III White	1pc
HG10.162/1	0955826	PTFE Cover DIAS III Black	1pc

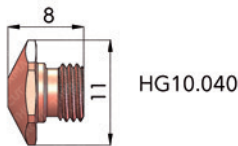

Part No.	Ref. No.	Description	Std. Pkg.
HG10.040	1589610	Nozzle - 2.0mm Blow Off	1pc
HG10.301	1384753	Nozzle CrossJet 2.0mm	1pc

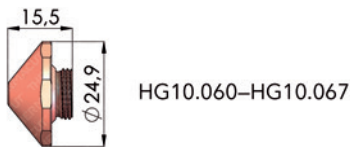

Part No.	Ref. No.	Description	Std. Pkg.	Part No.	Ref. No.	Description	Std. Pkg.
HG10.060	1324858	Nozzle EAA 0.8mm	10pcs	HG10.070	1373324	Nozzle EAB 0.8mm	10pcs
HG10.061	1324860	Nozzle EAA 1.0mm	10pcs	HG10.071	1373325	Nozzle EAB 1.0mm	10pcs
HG10.062	1324861	Nozzle EAA 1.2mm	10pcs	HG10.072	1373326	Nozzle EAB 1.2mm	10pcs
HG10.063	1324863	Nozzle EAA 1.4mm	10pcs	HG10.073	1373327	Nozzle EAB 1.4mm	10pcs
HG10.064	1324864	Nozzle EAA 1.7mm	10pcs	HG10.074	1373328	Nozzle EAB 1.7mm	10pcs
HG10.065	1324865	Nozzle EAA 2.0mm	10pcs	HG10.075	1373329	Nozzle EAB 2.0mm	10pcs
HG10.066	1324866	Nozzle EAA 2.3mm	10pcs	HG10.076	1373330	Nozzle EAB 2.3mm	10pcs
HG10.067	1324867	Nozzle EAA 2.7mm	10pcs	HG10.077	1373331	Nozzle EAB 2.7mm	10pcs

PolyTetraFluoroEthylene is a fluorocarbon-based polymer and is commonly abbreviated PTFE. The Teflon® brand of PTFE is manufactured only by DuPont® and is not sold by THERMACUT®. THERMACUT® purchases other brands of PTFE from various high quality manufacturers.

Last update of this page: 02/11/2023. See Revision history for details.

THERMACUT® REPLACEMENT PARTS SUITABLE FOR TRUMPF®
PARTS SUITABLE FOR TRUMPF® BRIGHTLINE™ SERIES AND COOLLINE™ SERIES

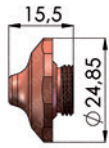

HG10.081–HG10.086

Part No.	Ref. No.	Description	Std. Pkg.	Part No.	Ref. No.	Description	Std. Pkg.
HG10.081	1664569	BrightLine™ Nozzle EAN 1.7mm	1pc	HG10.085	1633046	BrightLine™ Nozzle EAC 5.3mm	1pc
HG10.082	1664602	BrightLine™ Nozzle EAN 2.0mm	1pc	HG10.086	1809091	BrightLine™ Nozzle EAQ 6.0mm	1pc
HG10.083	1664625	BrightLine™ Nozzle EAN 2.5mm	1pc	HG10.087	1809421	BrightLine™ Nozzle EAQ 7.5mm	1pc
HG10.084	1835747	BrightLine™ Nozzle EAK 4.0mm	1pc	HG10.088	1886199	BrightLine™ Nozzle EAQ 9.5mm	1pc

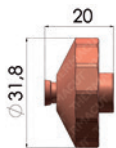

HG10.090

Part No.	Ref. No.	Description	Std. Pkg.	Part No.	Ref. No.	Description	Std. Pkg.
HG10.089	1774018	CoolLine™ Nozzle EFL 1.4mm	1pc	HG10.091	1774092	CoolLine™ Nozzle EFL 2.3mm	1pc
HG10.090	1774020	CoolLine™ Nozzle EFL 2.0mm	1pc				

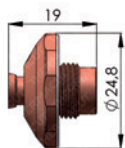

HG10.092–HG10.095

Part No.	Ref. No.	Description	Std. Pkg.
HG10.092	1879940	CoolLine™ Nozzle EGL D1.4 mm	10pcs
HG10.093	1879951	CoolLine™ Nozzle EGL D1.7 mm	10pcs
HG10.094	1879952	CoolLine™ Nozzle EGL D2.0 mm	10pcs
HG10.095	1879953	CoolLine™ Nozzle EGL D2.3 mm	10pcs

Last update of this page: 02/11/2023. See Revision history for details.

THERMACUT® REPLACEMENT PARTS SUITABLE FOR TRUMPF®

PARTS SUITABLE FOR TRUMPF® PERFORMANCE™ SERIES



HG10.096–HG10.098

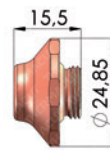

HG10.870

Part No.	Ref. No.	Description	Std. Pkg.	Part No.	Ref. No.	Description	Std. Pkg.
HG10.096	2059462	Nozzle EAU 2.5mm	10pcs	HG10.041	2253595	Nozzle EAU 10.0mm	10pcs
HG10.097	2060001	Nozzle EAU 3.0mm	10pcs	HG10.870	2491660	Nozzle CAU 10.0mm	10pcs
HG10.098	2060004	Nozzle EAU 4.0mm	10pcs				
HG10.099	2060025	Nozzle EAU 6.0mm	10pcs				

THERMACUT® REPLACEMENT PARTS SUITABLE FOR TRUMPF®

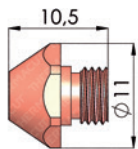

HG10.036–HG10.038
HG10.010–HG10.012
HG10.025
HG10.028

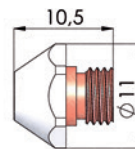

HG10.036/C
HG10.010/C–HG10.012/C
HG10.028/C

Part No.	Ref. No.	Description	Std. Pkg.	Part No.	Ref. No.	Description	Std. Pkg.
HG10.036	1354230	Nozzle EBD 0.8mm	10pcs	HG16.600	HG16.600	Nozzle 0.8mm	10pcs
HG10.036/C OD	1354230CP	Nozzle EBD 0.8mm HCP	10pcs	HG10.013	226939	Nozzle 1.0mm	10pcs
HG10.010	0212334	Nozzle EBD 1.0mm	10pcs	HG10.014	226940	Nozzle 1.4mm HD	10pcs
HG10.010/C	0212334CP	Nozzle EBD 1.0mm HCP	10pcs	HG10.015	227144	Nozzle 1.7mm HD	10pcs
HG10.025	HG10.025	Nozzle 1.0mm HD	10pcs	HG10.033	HG10.033	Nozzle 2.0mm HD	10pcs
HG10.037	1479581	Nozzle EBD 1.2mm	10pcs	HG10.029	HG10.029	Nozzle 2.3mm HD	10pcs
HG10.011	0216199	Nozzle EBD 1.4mm HD	10pcs				
HG10.011/C	0216199CP	Nozzle EBD 1.4mm HD HCP	10pcs				
HG10.012	0225213	Nozzle EBD 1.7mm HD	10pcs				
HG10.012/C	0225213CP	Nozzle EBD 1.7mm HD HCP	10pcs				
HG10.038	1487009	Nozzle EBD 2.0mm	10pcs				
HG10.028	0126156	Nozzle EBD 2.3mm HD	10pcs				
HG10.028/C OD	0126156CP	Nozzle EBD 2.3mm HD HCP	10pcs				

OD ON DEMAND – WE DO NOT KEEP THESE PARTS IN STOCK, COST IS SET ACCORDING TO THE ORDERED QUANTITY, DELIVERY TIME MAY DIFFER FROM STANDARD PRODUCTS.

Last update of this page: 05/01/2024. See Revision history for details.

THERMACUT®
THE CUTTING COMPANY®

WWW.THERMACUT.COM
TEL.: +420 556 423 440
SALES@THERMACUT.CZ

THERMACUT®, THE CUTTING COMPANY®, FHT-EX®, EX-TRAFIRE®, EX-TRACK®, EX-TRABEAM® AND EX-TRAFLEAME® ARE REGISTERED TRADEMARKS OF THERMACUT, K.S. AND MAY BE REGISTERED IN CZECH REPUBLIC AND/OR OTHER COUNTRIES. ALL OTHER TRADEMARKS ARE PROPERTIES OF THEIR RESPECTIVE OWNERS. THERMACUT® IS IN NO WAY AFFILIATED WITH TRUMPF®. MOST THERMACUT® PARTS ARE MADE FOR OR BY AN IBG COMPANY.
VALID FROM MARCH 2024 • PREVIOUS VERSION IS NO LONGER VALID. • © COPYRIGHT 2024 BY THERMACUT® CZECH REPUBLIC. ALL RIGHTS RESERVED.

THERMACUT® REPLACEMENT PARTS SUITABLE FOR TRUMPF®

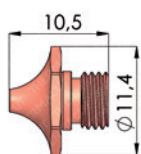

HG10.016

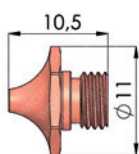

HG10.017
HG10.030

Part No.	Ref. No.	Description	Std. Pkg.	Part No.	Ref. No.	Description	Std. Pkg.
HG10.016	HG10.016	Nozzle 1.0mm	10pcs	HG10.225	0135320	Nozzle 1.0mm RE	10pcs
HG10.017	HG10.017	Nozzle 1.4mm HD	10pcs	HG10.226	HG10.226	Nozzle 1.2mm RE	10pcs
HG10.030 OD	HG10.030	Nozzle 2.3mm HD	10pcs	HG10.220 OD	0135318	Nozzle 1.4mm RE	10pcs
				HG10.221 OD	0126157	Nozzle 1.7mm RE	10pcs

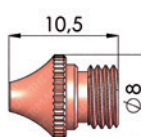

HG10.020-HG10.022
HG10.039

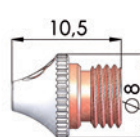

HG10.020/C
HG10.021/C

Part No.	Ref. No.	Description	Std. Pkg.	Part No.	Ref. No.	Description	Std. Pkg.
HG10.020	0913799	Nozzle EBG 0.8mm HD	10pcs	HG10.022/C	0913801CP	Nozzle EBG 1.4mm HD HCP	10pcs
HG10.020/C OD	0913799CP	Nozzle EBG 0.8mm HD HCP	10pcs	HG10.023	0937988	Nozzle EBF 1.7mm HD	10pcs
HG10.021	0913800	Nozzle EBG 1.0mm HD	10pcs	HG10.023/C	0937988CP	Nozzle EBF 1.7mm HD HCP	10pcs
HG10.021/C	0913800CP	Nozzle EBG 1.0mm HD HCP	10pcs	HG10.027	1487036	Nozzle EBF 2.0mm	10pcs
HG10.039	1487034	Nozzle EBG 1.2mm	10pcs	HG10.024	0937989	Nozzle EBF 2.3mm HD	10pcs
HG10.022	0913801	Nozzle EBG 1.4mm HD	10pcs	HG10.024/C	0937989CP	Nozzle 2.3mm HD HCP	10pcs

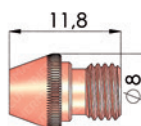

HG10.900-HG10.903

Part No.	Ref. No.	Description	Std. Pkg.	Part No.	Ref. No.	Description	Std. Pkg.
HG10.900	2241407-UR	Nozzle EBC X12	10pcs	HG10.904	2241409-UR	Nozzle EBC X40	10pcs
HG10.901	2085524-UR	Nozzle EBC X20	10pcs				
HG10.902	2241406-UR	Nozzle EBC X31	10pcs				
HG10.903	2241524-UR	Nozzle EBC X35	10pcs				

OD ON DEMAND – WE DO NOT KEEP THESE PARTS IN STOCK, COST IS SET ACCORDING TO THE ORDERED QUANTITY, DELIVERY TIME MAY DIFFER FROM STANDARD PRODUCTS.

Last update of this page: 29/03/2024. See Revision history for details.

THERMACUT®
THE CUTTING COMPANY®

WWW.THERMACUT.COM
TEL.: +420 556 423 440
SALES@THERMACUT.CZ

THERMACUT®, THE CUTTING COMPANY®, FHT-EX®, EX-TRAFIRE®, EX-TRACK®, EX-TRABEAM® AND EX-TRAFLEAME® ARE REGISTERED TRADEMARKS OF THERMACUT, K.S. AND MAY BE REGISTERED IN CZECH REPUBLIC AND/OR OTHER COUNTRIES. ALL OTHER TRADEMARKS ARE PROPERTIES OF THEIR RESPECTIVE OWNERS. THERMACUT® IS IN NO WAY AFFILIATED WITH TRUMPF®. MOST THERMACUT® PARTS ARE MADE FOR OR BY AN IBG COMPANY.
VALID FROM MARCH 2024 • PREVIOUS VERSION IS NO LONGER VALID. • © COPYRIGHT 2024 BY THERMACUT® CZECH REPUBLIC. ALL RIGHTS RESERVED.

THERMACUT® REPLACEMENT PARTS SUITABLE FOR TRUMPF®
OPTICS, SERVICE ITEMS AND SPARE PARTS
SUITABLE FOR TRUMPF®



LENSES SUITABLE FOR TRUMPF®

Part No.	Ref. No.	Description	Std. Pkg.	Part No.	Ref. No.	Description	Std. Pkg.
HG10.166/H	346104	3.75" ZnSe Meniscus lens High pressure lens (29bar), 38.1mm Effective focal length: 95.3mm Edge thickness: 7.4mm AR/AR for 10.6µm (absorption <0.20%)	1pc	HG10.167/HU	88114	5.00" ZnSe Meniscus lens - ULTRA LOW High pressure lens (29bar), 38.1mm Effective focal length: 127.0mm Edge thickness: 7.4mm AR/AR for 10.6µm (absorption <0.13%)	1pc
HG10.167/H	88114	5.00" ZnSe Meniscus lens High pressure lens (29bar), 38.1mm Effective focal length: 127.0mm Edge thickness: 7.4mm AR/AR for 10.6µm (absorption <0.20%)	1pc	HG10.168/HU	97517	7.50" ZnSe Meniscus lens - ULTRA LOW High pressure lens (29bar), 38.1mm Effective focal length: 190.5mm Edge thickness: 7.4mm AR/AR for 10.6µm (absorption <0.13%)	1pc
HG10.168/H	97517	7.50" ZnSe Meniscus lens High pressure lens (29bar), 38.1mm Effective focal length: 190.5mm Edge thickness: 7.4mm AR/AR for 10.6µm (absorption <0.20%)	1pc				
HG10.169/H	141972	9.00" ZnSe Meniscus lens High pressure lens (29bar), 38.1mm Effective focal length: 225.0mm Edge thickness: 7.4mm AR/AR for 10.6µm (absorption <0.20%)	1pc				
HG10.179/H	350163	10.00" ZnSe Meniscus lens High pressure lens (29bar), 38.1mm Effective focal length: 254.0mm Edge thickness: 7.4mm AR/AR for 10.6µm (absorption <0.20%)	1pc				
HG10.119/H*	HG10.119/H	ZnSe 50mm Lens ET8.9 FL170mm - w/o chip	1pc	HG10.126/H*	HG10.126/H	ZnSe 40mm Lens ET7.5 FL250mm - w/o chip	1pc
HG10.120/H*	HG10.120/H	ZnSe 50mm Lens ET8.9 FL175mm - w/o chip	1pc	HG10.127/H*	HG10.127/H	ZnSe 40 mm Lens ET7.5 FL130mm - chip	1pc
HG10.121/H*	HG10.121/H	ZnSe 50mm Lens ET8.9 FL250mm - w/o chip	1pc	HG10.128/H*	HG10.128/H	ZnSe 40 mm Lens ET7.5 FL250mm - chip	1pc
HG10.123/H*	HG10.123/H	ZnSe 50mm Lens ET8.9 FL250mm - chip	1pc	HG10.129/H*	HG10.129/H	ZnSe 40 mm Lens ET7.4 FL240mm Meniscus	1pc
HG10.124/H*	HG10.124/H	ZnSe 40mm Lens ET7.5 FL155mm - w/o chip	1pc				
HG10.125/H*	HG10.125/H	ZnSe 40mm Lens ET7.5 FL130mm - w/o chip	1pc				

PROTECTION WINDOWS SUITABLE FOR TRUMPF®

Part No.	Ref. No.	Description	Std. Pkg.
HG17.513	1614767	Protection Window D34.00mm × ET = 5.0mm	1pc
HG17.515	759720	Protection Window D55.00mm × ET = 1.5mm	1pc
HG17.526	766719	Protection Window D30.00mm × ET = 5.0mm	1pc

* BEFORE PURCHASING LENSES, PLEASE CHECK THE COUNTRY OF ORIGIN FOR POSSIBLE IMPORT RESTRICTIONS WITH YOUR SALES REPRESENTATIVE.
W/O WITHOUT

Last update of this page: 05/01/2024. See Revision history for details.

THERMACUT® REPLACEMENT PARTS SUITABLE FOR TRUMPF®

SERVICE ITEMS AND SPARE PARTS SUITABLE FOR TRUMPF®

SUITABLE FOR EXTRACTION UNIT

Part No.	Ref. No.	Description	Std. Pkg.	Part No.	Ref. No.	Description	Std. Pkg.
0345064	HG17.000	Filter Panel H13	1pc	0375600		Filter Panel H13 - DELTA 1200-10(12) 9 SB	1pc
0380757	HG17.003	Filter Panel H13 - MF-L 2000	1pc	0342812/146122/342682	HG17.002	Filter Panel	1pc
2260691		Filter Panel H13 - MF-8.4/8.5/8.6	1pc	0139809		Filter Panel H13	1pc
1746376		Filter Panel H13 - MF-L1000	1pc				

SUITABLE FOR TRUMPF® TC L2530

Railings

Part No.	Ref. No.	Description	Std. Pkg.	Part No.	Ref. No.	Description	Std. Pkg.
134401		Bellows X-axis	1pc	135399		Bellows Y-axis - buttons	1pc
135402/352332		Bellows X-axis	1pc	980133		Bellows Y-axis - velcro	1pc

Beam guideway

Part No.	Ref. No.	Description	Std. Pkg.	Part No.	Ref. No.	Description	Std. Pkg.
925803/2335181		Chest Bellows X-axis, right	1pc	939014/2335237		Chest Bellows Y-axis, rear	1pc
939013/2335287		Chest Bellows X-axis, left	1pc	910354/2342414		Chest Bellows Z-axis	1pc
925802/2335040		Chest Bellows Y-axis, front	1pc				
939012/2335236		Chest Bellows Y-axis, middle	1pc				

BELLOWS SUITABLE FOR TRUMPF® TC L3030™, L3020™

Railings

Part No.	Ref. No.	Description	Std. Pkg.
2012184/921742	HG17.100	Bellows X-axis	1pc
141394	HG17.101	Bellows Y-axis	1pc

Chest bellows

Part No.	Ref. No.	Description	Std. Pkg.	Part No.	Ref. No.	Description	Std. Pkg.
1667790/920715/124393/2356536	HG17.102	Chest Bellows X-axis, front	1pc	910354/2342414	HG17.106	Chest Bellows Z-axis	1pc
1667803/939015/2356581	HG17.103	Chest Bellows X-axis, rear	1pc				
1667801/920716/124394/2356537	HG17.104	Chest Bellows Y-axis, right	1pc				
1667805/939016/2356591	HG17.105	Chest Bellows Y-axis, left	1pc				

Disk bellows

Part No.	Ref. No.	Description	Std. Pkg.	Part No.	Ref. No.	Description	Std. Pkg.
1306466		Disk Bellows Y-axis, left	1pc	1306468		Disk Bellows X-axis, rear	1pc
1306467		Disk Bellows Y-axis, right	1pc	1306469		Disk Bellows X-axis, front	1pc

Last update of this page: 29/03/2024. See Revision history for details.

THERMACUT® REPLACEMENT PARTS SUITABLE FOR TRUMPF®

SERVICE ITEMS AND SPARE PARTS SUITABLE FOR TRUMPF®

BELLOWS SUITABLE FOR TRUMPF® TC L4030™

Railings

Part No.	Ref. No.	Description	Std. Pkg.
1883139/921870	HG17.110	Bellows X-axis	1pc
144949	HG17.111	Bellows Y-axis	1pc

Beam guideway

Part No.	Ref. No.	Description	Std. Pkg.	Part No.	Ref. No.	Description	Std. Pkg.
939017/2335182	HG17.112	Chest bellows X-axis, rear	1pc	910354/2342414	HG17.106	Chest bellows Z-axis	1pc
976624/2335292	HG17.113	Chest bellows X-axis, front	1pc				
920719/2335130	HG17.115	Chest bellows Y-axis, right	1pc				
938000/2335183	HG17.116	Chest bellows Y-axis, left	1pc				

BELLOWS SUITABLE FOR TRUMPF® TC L6030™

Railings

Part No.	Ref. No.	Description	Std. Pkg.
2012185/921871	HG17.150	Bellows X-axis	1pc
144949	HG17.111	Bellows Y-axis	1pc

Beam guideway

Part No.	Ref. No.	Description	Std. Pkg.	Part No.	Ref. No.	Description	Std. Pkg.
920730/2335161	HG17.151	Chest bellows X-axis, rear	1pc	910354/2342414	HG17.106	Chest bellows Z-axis	1pc
937999/2335246	HG17.152	Chest bellows X-axis, front	1pc				
920719/2335130	HG17.115	Chest bellows Y-axis, right	1pc				
938000/2335183	HG17.116	Chest bellows Y-axis, left	1pc				

BELLOWS SUITABLE FOR TRUMPF® TC L3050™, L5030

Railings

Part No.	Ref. No.	Description	Std. Pkg.	Part No.	Ref. No.	Description	Std. Pkg.
1873856/1596087/1302020/981757	HG17.122	Bellows X-axis, front & middle left	1pc	1865270	HG17.187	Railing cover X-axis, left (fiber L68)	1pc
981710	HG17.123	Bellows X-axis, front & rear right	1pc	1865268/1458866	HG17.162	Railing cover X-axis, right (fiber L68)	1pc
1873855/1596086/1307207	HG17.124	Bellows X-axis front & rear right	1pc	1595381/1879074		Bellows Y-axis (fiber)	1pc
18773857/1596088/1302018/981756	HG17.125	Bellows X-axis, rear left	1pc	979561	HG17.128	Bellows Z-axis, rear	1pc
1226193/0993338	HG17.126	Bellows y-axis right	1pc	1261298		Bellows Z-axis, front	1pc
1796166/1302386/981753/1949376	HG17.127	Bellows U-axis front & rear	1pc				

Last update of this page: 29/03/2024. See Revision history for details.

THERMACUT® REPLACEMENT PARTS SUITABLE FOR TRUMPF®
SERVICE ITEMS AND SPARE PARTS SUITABLE FOR TRUMPF®

BELLOWS SUITABLE FOR TRUMPF® TC L3050™, L5030

Beam guideway

Part No.	Ref. No.	Description	Std. Pkg.	Part No.	Ref. No.	Description	Std. Pkg.
978079/2335072	HG17.120	Chest Bellows U/X-axis	1pc	1353514		Combined Disk Bellows Y-axis, left	1pc
1271514		Disk Bellows U/X-axis	1pc	1353515		Combined Disk Bellows Y-axis, left	1pc
1323286		Disk Bellows U/X-axis	1pc	1496436	HG17.164	Disk Bellows Y-axis, left for 5030 L16	1pc
1226192	HG17.119	Combined Chest Bellows Y-axis, left	1pc	910354/2342414	HG17.106	Chest Bellows Z-axis	1pc

BELLOWS SUITABLE FOR TRUMPF® TC L4050™

Railings

Part No.	Ref. No.	Description	Std. Pkg.	Part No.	Ref. No.	Description	Std. Pkg.
1893488/1222529	HG17.140	Bellows X-axis, front & middle left	1pc	1946658		Bellows Y-axis (fiber 5040/6040)	1pc
1893485/1222573	HG17.141	Bellows X-axis, front & rear right	1pc	1222528	HG17.144	Bellows U-axis, front & rear	1pc
1893487/1222571	HG17.142	Bellows X-axis, rear left	1pc	979561	HG17.128	Bellows Z-axis, rear	1pc
1222111	HG17.143	Bellows Y-axis, right	1pc	1261298		Bellows Z-axis, front	1pc

Beam guideway

Part No.	Ref. No.	Description	Std. Pkg.	Part No.	Ref. No.	Description	Std. Pkg.
1222575/2334587	HG17.146	Chest Bellows X-axis, left	1pc	1222110	HG17.148	Combined Chest Bellows Y-axis, left	1pc
1306470		Disk Bellows X-axis, left	1pc	1353516/1306472	HG17.158	Combined Disk Bellows Y-axis, left	1pc
1222576	HG17.147	Chest Bellows X-axis, right	1pc	910354/2342414	HG17.106	Chest Bellows Z-axis	1pc
1306471		Disk Bellows X-axis, right	1pc				

SUITABLE FOR TRUMPF® 6050

Railings

Part No.	Ref. No.	Description	Std. Pkg.	Part No.	Ref. No.	Description	Std. Pkg.
1987171/1251452	HG17.153	Bellows X-axis, right	1pc	1222111	HG17.143	Bellows Y-axis, right	1pc
1987173/1251453	HG17.154	Bellows X-axis, left	1pc	1946658		Bellows Y-axis (fiber 5040/6040)	1pc
1987172/1251454	HG17.155	Bellows X-axis, left	1pc	979561	HG17.128	Bellows Z-axis, rear	1pc
1987174/1251455/1805789	HG17.156	Bellows U-axis	1pc				

Beam guideway

Part No.	Ref. No.	Description	Std. Pkg.	Part No.	Ref. No.	Description	Std. Pkg.
1222110	HG17.148	Combined Chest Bellows Y-axis, left	1pc	1306473	HG17.159	Disk Bellows X-axis, left	1pc
1353516/1306472	HG17.158	Combined Disk Bellows Y-axis, left	1pc	1306474	HG17.160	Disk Bellows X-axis, right	1pc

Last update of this page: 29/03/2024. See Revision history for details.

THERMACUT® REPLACEMENT PARTS SUITABLE FOR TRUMPF®

SERVICE ITEMS AND SPARE PARTS SUITABLE FOR TRUMPF®

SUITABLE FOR TRUMPF® 3030 (L20/L49)

Railings

Part No.	Ref. No.	Description	Std. Pkg.	Part No.	Ref. No.	Description	Std. Pkg.
1865269/1458867	HG17.161	Railing Cover X-axis, left	1pc	1595345	HG17.186	Bellows Z-axis (3030 L49)	1pc
1865268/1458866	HG17.162	Railing Cover X-axis, right	1pc				
1879074/1595381		Bellows Y-axis	1pc				
1512607	HG17.163	Bellows Z-axis	1pc				

Beam guideway

Part No.	Ref. No.	Description	Std. Pkg.	Part No.	Ref. No.	Description	Std. Pkg.
1496436	HG17.164	Combined Disk Bellows Y-axis, left	1pc	1458860	HG17.166	Disk Bellows X-axis, front left	1pc
1496435	HG17.165	Combined Disk Bellows Y-axis, right	1pc	1458861/1854030	HG17.167	Disk Bellows X-axis, rear left	1pc

SUITABLE FOR TRUMPF® 8030 (L60)

Railings

Part No.	Ref. No.	Description	Std. Pkg.	Part No.	Ref. No.	Description	Std. Pkg.
1761798/1626782		Railing Cover X-axis, lower left	1pc	1761994/1626771/1805022		Railing Cover Y-axis, upper right	1pc
1762044/1650240		Railing Cover X-axis, lower right	1pc	0386073		Railing Cover	
1761827/1626781/1805023		Railing Cover Y-axis, lower left	1pc				
1761826/1626780		Railing Cover Y-axis, upper left	1pc				

GAS AND WATER FILTERS

Part No.	Ref. No.	Description	Std. Pkg.	Part No.	Ref. No.	Description	Std. Pkg.
146152	HG17.130	Filtr Chisso CP10	1pc	123676/377004	HG17.133	Filter Insertion AKP 04/20S	1pc
1888631	HG17.136	Water Filter 20 inch	1pc	365781	HG17.134	Filter Insertion MFP 04/10	1pc
123674/377006	HG17.131	Air Filter Insertion FFP03	1pc	365782	HG17.135	Filter Insertion SMFP 04/10	1pc
123675/377005	HG17.132	Air Filter Insertion AIR/N ₂	1pc				

SUITABLE FOR COOLING AGGREGATE

Part No.	Ref. No.	Description	Std. Pkg.	Part No.	Ref. No.	Description	Std. Pkg.
		Air Filter 820×790×8mm (25pcs)	1pc	HG11.187	HG11.188	Air Filter 1530×1530×8mm (25pcs)	1pc
HG10.191	HG10.191	Air Filter 990×890×8mm (25pcs)	1pc	HG10.188	HG10.188	Air Filter 1670×660×8mm (25pcs)	1pc
HG10.190	HG10.190	Air Filter 1200×700×8mm (25pcs)	1pc	HG10.178	HG10.178	Air Filter 2420×550×8mm (25pcs)	1pc
HG10.187	HG10.187	Air Filter 1520×755×8mm (25pcs)	1pc	HG10.189	HG10.189	Air Filter 2420×560×8mm (25pcs)	1pc

Last update of this page: 29/03/2024. See Revision history for details.

THERMACUT® REPLACEMENT PARTS SUITABLE FOR TRUMPF®
SERVICE ITEMS AND SPARE PARTS SUITABLE FOR TRUMPF®

PRODUCTS FOR CLEANING

Part No.	Ref. No.	Description	Std. Pkg.	Part No.	Ref. No.	Description	Std. Pkg.
0367430/070681		Cotton Pads (50pcs)	1pc	0086452/1687226	HG10.173	Lens Cleaning Paper	1pc
		Cotton Swabs Long (50pcs)	1pc				
1222024		Knit Polyester Swabs (100pcs)	1pc				
2243506	HG10.174	Polish for Laser Lenses	1pc				

OILS AND LUBRICANTS

Part No.	Ref. No.	Description	Std. Pkg.	Part No.	Ref. No.	Description	Std. Pkg.
0356259	HG17.060	Cut Fluid 10L	1pc	111780	OS-10189	Replace Microlube GB 00, 5kg	1pc
0134336		Vacuum Pump Oil, 1L	1pc				
0368910	HG10.172	Tonna Oil "S32", 5L canister	1pc				
0368910		Tonna Oil "S32", 20L canister	1pc				
Part No.	Ref. No.	Description	Std. Pkg.				
223322	N-20144	Fixing Band	1pc				

Last update of this page: 29/03/2024. See Revision history for details.

THERMACUT® REPLACEMENT PARTS SUITABLE FOR RAYTOOLS™

Part No.	Ref. No.	Description	Std. Pkg.	Part No.	Ref. No.	Description	Std. Pkg.
HG11.051	120GJT0508	Nozzle 0.8mm	10pcs	HG11.061	120GJT0610	Double Nozzle 1.0mm HCP	10pcs
HG11.052	120GJT0510	Nozzle 1.0mm	10pcs	HG11.062	120GJT0612	Double Nozzle 1.2mm HCP	10pcs
HG11.053	120GJT0512	Nozzle 1.2mm	10pcs	HG11.063	120GJT0615	Double Nozzle 1.5mm HCP	10pcs
HG11.054	120GJT0515	Nozzle 1.5mm	10pcs	HG11.064	120GJT0620	Double Nozzle 2.0mm HCP	10pcs
HG11.055	120GJT0520	Nozzle 2.0mm	10pcs	HG11.065	120GJT0625	Double Nozzle 2.5mm HCP	10pcs
HG11.056	120GJT0525	Nozzle 2.5mm	10pcs	HG11.066	120GJT0630	Double Nozzle 3.0mm HCP	10pcs
HG11.057	120GJT0530	Nozzle 3.0mm	10pcs	HG11.067	120GJT0635	Double Nozzle 3.5mm HCP	10pcs
HG11.058	120GJT0535	Nozzle 3.5mm	10pcs	HG11.068	120GJT0640	Double Nozzle 4.0mm HCP	10pcs
HG11.059	120GJT0540	Nozzle 4.0mm	10pcs	HG11.069	HG11.069	Protection Window 27.9 × 4.1	1pc
HG11.060	120GJT0608	Double Nozzle 0.8mm HCP	10pcs	HG11.050	120274100B	Nozzle Holder	1pc

THERMACUT® REPLACEMENT PARTS SUITABLE FOR BODOR™

Part No.	Ref. No.	Description	Std. Pkg.	Part No.	Ref. No.	Description	Std. Pkg.
HG11.070	HG11.070	Nozzle 0.8mm	10pcs	HG11.082	HG11.082	Double Nozzle 1.0mm	10pcs
HG11.071	HG11.071	Nozzle 1.0mm	10pcs	HG11.083	HG11.083	Double Nozzle 1.2mm	10pcs
HG11.072	HG11.072	Nozzle 1.2mm	10pcs	HG11.084	HG11.084	Double Nozzle 1.5mm	10pcs
HG11.073	HG11.073	Nozzle 1.5mm	10pcs	HG11.085	HG11.085	Double Nozzle 2.0mm	10pcs
HG11.074	HG11.074	Nozzle 2.0mm	10pcs	HG11.086	HG11.086	Double Nozzle 2.5mm	10pcs
HG11.075	HG11.075	Nozzle 2.5mm	10pcs	HG11.087	HG11.087	Double Nozzle 3.0mm	10pcs
HG11.076	HG11.076	Nozzle 3.0mm	10pcs	HG11.088	HG11.088	Double Nozzle 3.5mm	10pcs
HG11.077	HG11.077	Nozzle 3.5mm	10pcs	HG11.089	HG11.089	Double Nozzle 4.0mm	10pcs
HG11.078	HG11.078	Nozzle 4.0mm	10pcs	HG11.090	HG11.090	Double Nozzle 4.5mm	10pcs
HG11.079	HG11.079	Nozzle 4.5mm	10pcs	HG11.091	HG11.091	Double Nozzle 5.0mm	10pcs
HG11.080	HG11.080	Nozzle 5.0mm	10pcs	HG17.524	P0595-56801	Protection Window D37.00mm × ET = 7.0mm	1pc
HG11.081	HG11.081	Double Nozzle 0.8mm	10pcs	HG11.050	120274100B	Nozzle Holder	1pc

Last update of this page: 10/05/2021. See Revision history for details.

THERMACUT®
THE CUTTING COMPANY®

WWW.THERMACUT.COM
TEL.: +420 556 423 440
SALES@THERMACUT.CZ

THERMACUT®, THE CUTTING COMPANY®, FHT-EX®, EX-TRAFIRE®, EX-TRACK®, EX-TRABEAM® AND EX-TRAFLEAME® ARE REGISTERED TRADEMARKS OF THERMACUT, K.S. AND MAY BE REGISTERED IN CZECH REPUBLIC AND/OR OTHER COUNTRIES. ALL OTHER TRADEMARKS ARE PROPERTIES OF THEIR RESPECTIVE OWNERS. THERMACUT® IS IN NO WAY AFFILIATED WITH BODOR™ AND RAYTOOLS™. MOST THERMACUT® PARTS ARE MADE FOR OR BY AN IBG COMPANY.
VALID FROM MARCH 2024 • PREVIOUS VERSION IS NO LONGER VALID. • © COPYRIGHT 2024 BY THERMACUT® CZECH REPUBLIC. ALL RIGHTS RESERVED.

REVISION HISTORY

INTRODUCTORY SECTION - Revision on PAGES 3-6 - 29/03/2024 - Croatian contact information changed and moved to Sales cooperation with ABICOR-BINZEL section. Hungarian contact information changed and moved to Other sales cooperation section. Ukrainian contact information changed. South African contact information added.

BYSTRONIC® SECTION - Revision on PAGE 13 - 29/03/2024 - Part HG11.340 added to the table. Description of parts HG12.341, HG12.342, HG12.339 changed.

Precitec® SECTION - Revision on PAGE 27 - 29/03/2024 - Parts HG11.106, HG11.108, HG11.020, HG11.023, HG11.024 added to the picture.

Precitec® SECTION - Revision on PAGE 31 - 29/03/2024 - Description of parts HG17.511, HG17.514, HG17.524, HG17.525, HG17.527, HG17.512 changed.

TRUMPF® SECTION - Revision on PAGE 38 - 29/03/2024 - Description of parts HG10.023, HG10.023/C, HG10.027, HG10.024 changed.

TRUMPF® SECTION - Revision on PAGES 40-44 - 29/03/2024 - Complete renewal of the section.

INTRODUCTORY SECTION - Revision on PAGES 3, 4, 6 - 29/01/2024 - German and USA contact information moved to Subsidiaries section. Russian and Vietnamese contact information removed. Argentine contact information added.

Precitec® SECTION - Revision on PAGE 26 - 29/01/2024 - Part HG10.230 added to the picture and to the table.

BLM® SECTION - Revision on PAGE 30 - 29/01/2024 - Part HG11.250 added to the picture and to the table.

AMADA® SECTION - Revision on PAGE 9 - 05/01/2024 - Parts HG15.029/HU, HG15.029/H removed from the table.

BYSTRONIC® SECTION - Revision on PAGE 11 - 05/01/2024 - Parts HG10.437, HG10.438 removed from the picture and from the table.

CINCINNATI® SECTION - Revision on PAGE 15 - 05/01/2024 - Part HG12.018 removed from the table.

MAZAK®, MITSUBISHI® SECTION - Revision on PAGES 18, 23, 25 - 05/01/2024 - Part HG15.029/H removed from the table.

MAZAK®, Precitec®, PRIMA POWER® SECTION - Revision on PAGES 18, 23, 30, 33 - 05/01/2024 - Part HG10.620/H removed from the table.

MITSUBISHI® SECTION - Revision on PAGE 25 - 05/01/2024 - Part HG15.029/HU removed from the table.

Precitec® SECTION - Revision on PAGE 29 - 05/01/2024 - Part HG11.013 removed from the table.

BLM® ADIGET™ SECTION - Revision on PAGE 30 - 05/01/2024 - Part HG10.230 removed from the picture and from the table.